



# VAN ISLE WATER

The Water System Experts

Since 1972

CELEBRATING

50

YEARS

1972-2022

2022

PONDS & WATERGARDENS

[VANISLEWATER.COM](http://VANISLEWATER.COM)

# Terms And Conditions

**Terms of Payment:** All product shipped from VAN ISLE WATER will be C.O.D. unless prior credit approval is obtained. C.O.D. shipments will be VISA, MC, or Certified Cheque prior to shipping. Qualified accounts have net 30 days from time of order.

**Prices & Taxes:** Catalogue is "List" pricing in Canadian dollars. "List" pricing is only suggested retail pricing and not actual. Actual retail pricing varies by product and region. All prices are as of date of printing and are subject to change without notice. Van Isle Water is not responsible for printing errors. Buyer shall pay all applicable taxes.

**Freight Policy:** Freight is prepaid on \$1000 net pre tax value for net 30 account customers. Items requiring special handling such as dangerous goods and oversize products are designated by a "  " symbol and are exclusive of prepaid freight. Van Isle Water will use the carrier of its choice.

**Freight Claims:** Van Isle Water does not assume responsibility for freight damage. All freight damage and shipping discrepancies must be claimed within 48 hours of receipt of goods. Customer must inspect shipments for damage and make claim with carrier.

**Short Shipment:** Van Isle Water must be notified of any short shipments within 48 hours of receipt of goods with copy of carrier waybill and customer count.

**Return Goods:** Return goods must be authorized by Van Isle Water. A copy of original invoice must accompany all returns. All returns must be shipped prepaid freight and are subject to a restocking fee up to 25%. Product damaged in freight return will not be accepted. Credit will be issued to account for future purchases. No returns after 30 days. Special order items are not returnable.

**Warranty:** All defective items within the manufactures warranty period must be authorized first and returned to Van Isle Water with a RGA#. Customer is responsible for return of item(s) and all freight costs. Item(s) will either be replaced or repaired at Van Isle Water's discretion. Item(s) sent back must be accompanied with customer proof of purchase and retail customer receipt. Shipment of replaced or repaired item will be responsibility of customer. Replacement or repaired items may be added to a prepaid shipping order.

## Contact

### Victoria, BC

461 Dupplin Rd,  
Victoria, BC V8Z 1B8  
Phone: 250-383-7145  
Toll-Free: 1-888-444-8497  
Fax: 250-385-1216  
sales@vanislewater.com

**Head Office**  
Hours of Operation:  
Mon to Fri 7:30 am - 5:00 pm  
Sat: 8:00 am - noon  
Sun: Closed

### Administration:

admin@vanislewater.com

### Sales:

sales@vanislewater.com

### Courtenay, BC

260B Tsolum Rd,  
Courtenay, BC V9N 3R2  
Phone: 250-338-8737  
Toll-Free: 1-800-665-8311  
Fax: 250-338-7933  
courtenay@vanislewater.com

Hours of Operation:  
Mon to Fri 7:30 am - 5:00 pm  
Sat: Closed  
Sun: Closed

### Website Support:

websupport@vanislewater.com

### Surrey, BC

800-10281 Grace Rd,  
Surrey, BC V3V 3V7  
Phone: 778-357-0257  
surrey@vanislewater.com

Mon to Fri 8:00 am - 4:30 pm  
Saturday: Closed  
Sunday: Closed

### Shipping/Receiving:

shipping@vanislewater.com

## FOUNTAIN PUMPS

Atlantic's Fountain Pumps offer everything you want in a small pump line, with large, sturdy pre-filters, integrated flow controls, versatile base plates and small diameter power plugs. Sized to fit even the smallest applications, these pumps still deliver big performance, with higher head heights and lower wattages than the competition. Trust Atlantic for all your fountain pump needs!



- Integrated flow adjustment.
- Includes 1/2" and 3/4" outlet fitting.
- Integrated Flow Adjustment.
- **Limited Warranty:** 1 year.

Model	GPH	Watts	Disc.	Cord	Case	Item #	List	GPH Flow @ Feet of Head			
								2.5'	5'	7.5'	
100	120	7	1/2" MIPT	6'	12	<a href="#">ATL-FP100</a>	2.5'	-	-	-	
200	175	9.5	1/2" MIPT	6'	12	<a href="#">ATL-FP200</a>	100	4.5'	-	-	
300	325	16	1/2" FIPT	16'	6	<a href="#">ATL-FP300</a>	230	90	6'	-	
400	380	24	1/2" FIPT	16'	6	<a href="#">ATL-FP400</a>	290	180	7.5'	-	
500	525	33	1/2" FIPT	16'	6	<a href="#">ATL-FP500</a>	430	300	75	8'	



## FOUNTAIN PUMPS

Oase Fountain Pumps are ideal for small bubbling stones, statuary, and decorative fountains of any type. Their compact sizes make it easy to install in small crevices. They can operate in as little as 1/2" of water depth. The output flow rate can be adjusted easily with a front facing mechanical slider.



- Smaller power cord plug size for easier setup.
- Quiet operation.
- Integrated Flow Adjustment
- **Limited Warranty:** 3 year.

Model	GPH	Watts	Disc.	Cord	Case	Item #	List	GPH Flow @ Feet of Head								
								1'	2'	3'	4'	5'	6'	7'	8'	
90	90	4	1/2" MIPT	6'	6	<a href="#">OAS-45417</a>	65	35	2.8'							
150	150	7	1/2" MIPT	6'	6	<a href="#">OAS-45413</a>	110	60	25	3.6'						
320	320	23	1/2" FIPT	16'	4	<a href="#">OAS-45414</a>	275	230	180	130	75	6.2'				
525	525	42	1/2" FIPT	16'	4	<a href="#">OAS-45416</a>	465	400	340	275	220	155	100	7.9'		



## AQUARIUS FOUNTAIN SET ECO

**Water feature set with controllable second outlet and three nozzle choices.**

- Compact fountain set provides multiple decorative display options.
- Comes with 3 spray heads and adjustable diverter, making it perfect for fountains and water gardens.
- Energy efficient motors keeps operating costs to a minimum, with proprietary grounding plate for unparalleled safety.
- Easy to install, with telescopic pipe extension for water depths from 10" to 24".
- Integrated swivel head makes it simple to correctly align the display nozzle even in water features with uneven bottoms or shelves.
- Valved diverter can power an optional decorative feature using 1/2" to 1" pipe.
- Thermal protection shuts pump off if pump overheats, preventing damage.
- Ribbed intake screen protects pump and keeps debris from blocking water flow.

Model	Max Flow	Watts	Max Head	Item #	List
250	250 gph	12	4.2 ft.	<a href="#">OAS-77378</a>	
550	550 gph	16	6.9 ft.	<a href="#">OAS-77379</a>	
825	825 gph	27	8.5 ft.	<a href="#">OAS-77380</a>	
1100	1100 gph	42	9.8 ft.	<a href="#">OAS-77381</a>	



## FILTRAL

A multi-functional, compact, pond technology solution designed for preformed and small ponds. This compact filter unit with integrated UV and pump guarantees clear, healthy pond water.

- Includes nozzle set.
- **Limited Warranty:** 2 years.
- Hose connection : 1/2" MIPT.
- 16' power cord.

Max. Pond (no fish)	Max. Flow	Max. Head	UV	Watts	Item #	List
700	250 gph	4'	7 W	30	OAS-40349	
1,300	580 gph	7.5'	9 W	52	<a href="#">OAS-42749</a>	



## FILTRAL UVC

Versatile, economical, all-in-one units integrate pump, filtration, circulation, aeration and decorative elements, in your choice of three sizes.

- Combines mechanical, biological and UV filtration with multiple nozzles and aeration (800 & 1600 only) for water features up to 1600 gallons.
- Easy to install, easy to maintain and provide crystal clear water, guaranteed.
- Pivoting telescoping nozzle accommodates uneven surfaces, while built-in flow control and diverter valve can run an optional small secondary water feature.
- Integrated grounding plate protects entire water feature with unparalleled safety

Pond Volume	Watts	UVC	Max Head	Cord	Item #	List
400 gal	20	5W	4'	15'	<a href="#">OAS-76004</a>	
800 gal	22	9W	4'	15'	<a href="#">OAS-76005</a>	
1600 gal	50	13W	6'	15'	<a href="#">OAS-76006</a>	



## WATERFALL PUMPS

Sized to fit even the smallest applications, these pumps still deliver big performance, with higher head heights and lower wattages than the competition.

- Energy efficient motor, saves power – and money – in operation.
- Grounding plate provides unparalleled protection against electrical hazards in your pond.
- Uncompromisingly reliable: high cleaning force, it pumps pond water and coarse debris particles, up to 1/16" into a filter.
- 20' power cord on all models.
- **Limited Warranty:** 3 year.



Model	GPH	Watts	Disc.	Case	Item #	List	GPH Flow @ Feet of Head						
							5'	10'	15'	20'	25'	30'	
1650	1650	70	1 1/4" MIPT	2	<a href="#">OAS-45421</a>		1100	600	<b>16.5'</b>				
2300	2300	130	1 1/4" MIPT	2	<a href="#">OAS-45422</a>		1850	1400	750	<b>20'</b>			
3700	3700	170	1 1/2" FIPT	2	<a href="#">OAS-45423</a>		3000	2300	1450	<b>21'</b>			
5150	5150	230	2" FIPT	2	<a href="#">OAS-45424</a>		4300	3500	2250	950	<b>23.5'</b>		
6600	6600	460	2" FIPT	1	<a href="#">OAS-45425</a>		5550	4500	3000	1750	500	<b>26.5'</b>	
8000	8000	600	2" FIPT	1	<a href="#">OAS-45426</a>		6500	5250	4000	2500	1250	<b>32'</b>	

## SWIMSKIM

The SwimSkim floating in-pond skimmer is the ideal addition or retrofit to any pond. In addition to removing leaves and dust from the water surface, the SwimSkim also improves water quality by increasing water circulation and air injection. Designed for ponds up to 270' sq/ft.

- Easy to install.
- Simple to maintain.
- Air injection 41 lpm.
- **Limited Warranty:** 2 year.

GPH	Watts	Cord	W x D x H	Item #	List
800	40	15'	12" x 13" x 10"	<a href="#">OAS-50040</a>	



## TRITON UNIVERSAL CHECK VALVE

The "swing style" Triton Check Valve features a 2" socket union on the inlet, 2" or 1-1/2" socket unions for the outlet, a molded in 90 elbow, and a slim design that allows clearance when installed with direct drive pumps. Works with all 1-1/2" and 2" pump outlets.

- Includes insert adapters for 1"-1 1/2" non-kink.

Inlet	Outlet	Item #	List
2" Socket	1.5" or 2" Socket	<a href="#">ATL-TR215CV</a>	



## TIDALWAVE TT

The TT-Series line are specifically designed to be clog-resistant and hard water-tolerant, making them the perfect choice for waterfalls & filters.

- Large threaded inlet and outlet for less restriction and greater flows.
- Quarter-turn volute provides access to impeller without the use of tools.
- Heavy-duty pre-filter locks in place. Large openings and increased surface area resist clogging.
- Three vane hybrid impeller improves flows and passes solids easily.
- All models feature 20' power cord.
- **Limited Warranty:** 3 years.



GPH	Watts	Suct. / Disc.	Item #	List	GPH Flow @ Feet of Head					
					1'	5'	10'	15'	20'	25'
1,640	101	1 1/2"	<a href="#">ATL-TT1500</a>		-	1,060	350	<b>15'</b>	-	-
2,640	115	1 1/2"	<a href="#">ATL-TT2000</a>		-	1,760	715	<b>16'</b>	-	-
3,000	173	1 1/2"	<a href="#">ATL-TT3000</a>		-	2,180	1,215	475	<b>20'</b>	-
4,490	230	1 1/2"	<a href="#">ATL-TT4000</a>		-	3,330	1,785	700	<b>20'</b>	-
5,150	310	2"	<a href="#">ATL-TT5000</a>		-	4,255	3,170	1,615	<b>22'</b>	-
6,600	334	2"	<a href="#">ATL-TT6000</a>		-	4,915	3,065	1,480	<b>23'</b>	-
7,650	520	2" / 3"	<a href="#">ATL-TT7500</a>		-	6,300	4,610	2,860	1,250	<b>25'</b>
8,800	587	2" / 3"	<a href="#">ATL-TT9000</a>		-	7,470	6,210	4,490	2,695	<b>28'</b>

## VARIABLE SPEED CONTROLLER

Vary the output of your asynchronous pumps wirelessly by remote control! The VSC allows you to set both on and off times as well as drop to 25% of the total flow, in 10 level adjustments.

- Digital read out displays time of day and on/off times.
- Rugged Weatherproof housing.
- **Limited Warranty:** 3 years.
- 6' power cord.
- Works with Atlantic TT & TW series pumps up to 800 watts.
- Multiple units can be synchronized to one remote.



Item#	List
ATL-TWVSC	

Can be controlled via a smartphone using Tidal Wave VSC App.



## AQUAMAX ECO CLASSIC

The Aquamax Eco Classic offers you the opportunity to purchase the world renowned Aquamax at a fantastic price. These pumps are ideal for feeding filters and waterfalls.

- Low profile design.
- Quiet operation even when run in-line.
- Solids handling- can handle coarse debris 1/3" in size.
- "Environmental Function Control" provides built in dry run protection.
- 20' power cord on all models.
- **Limited Warranty:** 3 years.



Model	GPH	Watts	Suct. / Disc.	Item#	List	GPH Flow @ Feet of Head						
						2'	4'	6'	8'	10'	12'	14'
1200	1,200	45	1 1/2" / 2"	<a href="#">OAS-40347</a>		900	635	350	<b>9'</b>	-	-	-
1900	1,995	70	1 1/2" / 2"	<a href="#">OAS-57620</a>		1,600	1,300	920	430	<b>10'</b>	-	-
2700	2,691	110	1 1/2" / 2"	<a href="#">OAS-57621</a>		2,375	1,975	1,520	1,000	375	<b>11'</b>	-
3600	3,619	150	1 1/2" / 2"	<a href="#">OAS-57623</a>		3,250	2,820	2,375	1,850	1,500	500	<b>13'</b>

## AQUAMAX ECO PREMIUM

Dual-suction, solids-handling, frost protection down to -20°C, and intelligent pump protection from thermal overload, blockage and dry running, make these the most advanced pond pumps on the market!

- Quiet operation even when run in-line.
- Ideal for use with pressure & gravity filtration - solids handling up to 3/8".
- Optional satellite filter or Aquaskim compatible.
- Equipped with hose tails or PVC connections.
- 20' power cord on all models.
- **Limited Warranty: 5 years.**



Model	GPH	Watts	Suct / Disc.	Item #	List	GPH Flow @ Feet of Head										
						2'	4'	6'	8'	10'	12'	14'	16'	18'		
2000	1,981	65	1 1/2" / 2"	<a href="#">OAS-57499</a>												
3000	2,985	110	1 1/2" / 2"	<a href="#">OAS-57500</a>		1,675	1,175	750	350	10'	-	-	-	-		
4000	4,006	150	1 1/2" / 2"	<a href="#">OAS-57501</a>		2,450	1,900	1,400	850	11'	-	-	-	-		
Satellite Filter Sold Separately				<a href="#">OAS-51074</a>		3,400	2,750	2,150	1,550	900	13'	-	-	-		

## PROFIMAX

Perfect for applications with large amounts of debris such as Koi ponds and heavily stocked water gardens.

- Pumps coarse debris up to 3/8" in size.
- Suitable submerged or in-line.
- Ideal for large scale filtration applications.
- Patented frost protection down to -20°C.
- 20' power cord.
- **Limited Warranty: 5 years.**



Model	GPH	Watts	Suct. / Disc.	Item #	List	GPH Flow @ Feet of Head				
						5'	10'	15'	20'	25'
7000	7080	660	2"	<a href="#">OAS-50296</a>		6100	5100	4000	2600	25'

## NEPTUN

High-performance pumps with compact dimensions. Ideal for use in statuary fountains, indoor decorative fountains, in the garden or on the patio.

- Can be run submersed or in-line.
- Patented frost protection down to -20°C.
- Extremely quiet operation.
- Built in flow control.
- 20' power cord on all models.
- **Limited Warranty: 5 year.**



GPH	Watts	Disc.	Item #	List	GPH Flow @ Feet of Head						
					1'	3'	5'	7'	10'	15'	20'
1,600	100	1"	<a href="#">OAS-57394</a>		1,500	1,350	1,200	950	715	16'	-
2,600	220	1 1/2"	<a href="#">OAS-57096</a>		2,500	2,250	2,050	1,800	1,450	750	20'

## AQUA+ SUBMERSIBLE WATERFALL PUMP

Energy efficient and durable, Basin pumps are engineered for continuous duty. Even in koi ponds where the pumps need to run all year long. For all of your pond and water feature needs, Basin Pumps are the product for the job!

- Underwater Use Only. • Oil Free Motor
- Economy Saving. • **Warranty: 2 years.**
- 16' Electric Cord.

GPH	Max. Height	Outlet	Item #	List	GPH Flow @ Feet of Head						
					1'	5'	10'	15'	20'	25'	
1150	10'	1" MIPT	<a href="#">WG-PC1150</a>		1150	610	18				
2050	10'	1 1/4" MNPT	<a href="#">WG-PC2050</a>		2050	1120	620				
3850	20'	1 3/4" MNPT	<a href="#">WG-PC3850</a>		3850	3100	2200	1100			
5250	25'	1 3/4" MNPT	<a href="#">WG-PC5250</a>		5250	4750	4250	3300	1850	1025	
7850	25'	2" MNPT	<a href="#">WG-PC7850</a>		7850	7260	6250	5150	3004	1310	

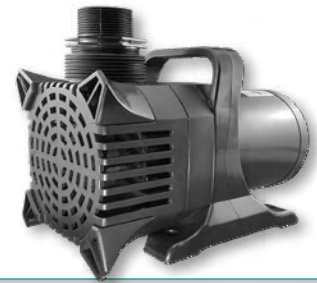

## ShinMaywa

### NORUS

One of the most reliable and durable pumps sold in today's watergarden market. Corrosion resistant due to the 304 stainless steel and poly amide fiber reinforced resin body, and built for continuous duty.

- Dual Mechanical Shaft Seals.
- Anti-wicking cable entry.
- 1 1/4" Solids handling.
- 33' Power cord (20' on 1/5 HP).
- Designed & built in Japan.
- **Limited Warranty: 2 years.**

HP	GPH	Watts 115v	Disc.	Item #	List	GPH Flow @ Feet of Head							
						5'	10'	15'	20'	25'	30'	35'	40'
1/5	3,300	330	2"	<a href="#">SHI-02S</a>		2,700	1,800	900	19'	-	-	-	-
1/3	4,800	484	2"	<a href="#">SHI-03S</a>		3,960	3,000	2,100	1,320	28'	-	-	-
1/2	5,700	605	2"	<a href="#">SHI-05S</a>		5,220	4,260	3,480	2,520	1,800	1,080	36'	-
1	7,000	1100	2"	<a href="#">SHI-10S</a>		6,720	6,000	5,280	4,800	4,080	3,180	2,280	48'
1	11,000	1210	2"	<a href="#">SHI-1XS</a>		10,200	9,000	7,200	5,700	3,780	2,160	34'	-



## LEADER

### ECOSUB

Fish safe, oil-free, high quality pump for ponds and waterfalls. Corrosion proof with ceramic shaft sleeve for long life. No screws to corrode or vibrate loose. Energy efficient motor.

- Cord length 16'.
- Made in Italy.

GPH	Watts	Discharge	Item #	List	GPH Flow @ Feet of Head					
					5'	10'	15'	20'	25'	30'
1,740	220	1 1/4"	<a href="#">LEA-ES400</a>		1,440	1,320	780	20'	-	-
2,220	300	1 1/4"	<a href="#">LEA-ES410</a>		2,040	1,920	1,320	660	23'	-
3,960	700	1 1/4"	<a href="#">LEA-ES420</a>		3,780	3,660	3,180	2,520	1,260	31'



### SOLID ANSWER

Leader Submersibles have set a new standard in pump technology with environmentally friendly, oil-free motors, capacitor start for instant torque and double ball bearings for high efficiency and quiet operation.

- 1 1/8" solids handling.
- Can be installed vertically or horizontally.
- Made in Italy.
- Cord length 16'.

GPH	Watts	Disc.	Item #	List	GPH Flow @ Feet of Head						
					4'	8'	12'	16'	20'	24'	28'
1,450	235	1 1/4"	<a href="#">LEA-DW1200</a>		1,200	720	12'	-	-	-	-
1,930	320	1 1/4"	<a href="#">LEA-DW2000</a>		1,880	1,280	840	16'	-	-	-
3,360	880	1 1/4"	LEA-DW3600		3,100	2,880	2,640	2,260	1,900	1,080	30'



### BVP

Heavy duty submersible pump for large waterfall applications. Suitable to pump dirty water containing particles up to a maximum diameter of 1-1/4". Anti-corrosive and rust-proof materials.

- 1 1/4" solids handling.
- Oil free.
- Made in Italy.
- Cord length 16'.

GPH	Watts	Disc.	Item #	List	GPH Flow @ Feet of Head								
					4'	8'	12'	16'	20'	24'	28'	32'	36'
5,280	1000	1 1/2"	<a href="#">LEA-BVP5000</a>		5,040	4,800	4,320	3,840	3,240	2,400	1,320	720	36'
6,600	1100	1 1/2"	LEA-BVP6500		6,180	5,860	5,400	4,900	4,360	3,645	2,850	2,060	39'



## FOUNTAIN HEAD KITS

Compatible with all mag drive pumps, these versatile fountain heads pivot to make leveling easy, telescope to adjustable heights and feature four different spray patterns to choose from.

Model	Inlet	Use With Pump Flows	Item #	List
51262	1/2" FIPT	180-370 GPH	<a href="#">OAS-51262</a>	
<b>Includes: Bell, Jets, Calyx &amp; Vulcan nozzles.</b>				
2575	3/4" FIPT	250-750 GPH	<a href="#">ATL-MDFH2575</a>	
1020	1" FIPT	1000-2000 GPH	<a href="#">ATL-MDFH1020</a>	
<b>Includes: Bell, Blossom, Daisy &amp; Trumpet nozzles.</b>				



## OASE FOUNTAIN NOZZLES



Lava

Size    Item #

Lava    1"    [OAS-55881](#)

Vulkan    1"    [OAS-55882](#)



Vulkan

List



Frothy

Size    Item #    List

Frothy    1"    [OAS-53224](#)

Nozzle Extension    1"    [OAS-53227](#)

## BRASS FOUNTAIN NOZZLES



TG

Size    Item #

Cascade    2"    [HG-TG2](#)

Mushroom    1"    [HG-C1](#)

1 1/2"    [HG-C15](#)



C

List



GM

Size

Trumpet    1"    [HG-GM1](#)

1 1/2"    [HG-GM15](#)

Blossom 3-Tier    1"    [HG-F1](#)



F1

List



FA

Size    Item #

Cluster    1"    [HG-FA1](#)

1 1/2"    [HG-FA15](#)

Trumpet w/  
Center Shot    1"    [HG-JM1](#)



JM

List



R

Size

Vulcan 3-Tier  
Adjustable    1 1/2"    [HG-R15](#)

Item #    List





## WATER JET LIGHTING

- Luminous, coloured, laminar water arches for a special charm in the garden.
- Variations of jet lengths, jet height, and RGB colours are played back in programs.
- The effects can be conveniently selected via remote control from a free distance of up to 250'.
- The water jet angle can be individually adjusted.
- Your favorite colour of the water arch can be set easily.
- Maximum jet length 6', maximum jet height 3'.
- "Plug'n Spray" principle enables easy installation.
- Low energy consumption.
- Included in the scope of delivery: 2-unit set Water Jet Lighting, pump, external control unit, transformer and cable.
- **Limited Warranty:** 3 years.



Light Colour	Watts	Item #	List
RGB	41	<a href="#">OAS-50355</a>	

## WATER QUINTET FOUNTAIN

- High quality water feature with five varying fountains, including LED lighting.
- "Plug'n Spray" principle: Immediately ready for use and easy connection.
- Features pre-programmed effects with variations in fountain height (12" - 55") and light intensity can be played back in permanently set programs.
- The programs can be conveniently selected via remote control from a distance of up to 250'.
- Included in the scope of delivery: 5 pumps / nozzles, external control unit, transformer and cables.
- Flexible setup on a wide variety of substrates.
- Low energy consumption.
- **Limited Warranty:** 3 years.



	Watts	Item #	List
Quintet	50	<a href="#">OAS-50354</a>	

## QUINTET INSTALL TIP:

With most installations of the Water Quintet one will need to construct a reservoir to store the water. You can use Atlantic Eco-Blox located on Page 26.



## FLOATING FOUNTAIN W/ LIGHTS

A beautiful water accent that aerates and decorates a large body of water.

- For ponds up to 2,000 sq/ft.
- Aerates and decorates large ponds.
- 3 fountainheads included (Trumpet, Single-Tier, & 3-Tier).
- 3 - 1 watt, LED lights with dusk-to-dawn sensor.
- 150' mooring line included.
- Minimum operating depth of 2.5'.
- **Limited Warranty:** 3 years.



LED Lights	Voltage	Watts	Cord	Item #	List
3 - 1 watt	120	130	50'	<a href="#">OAS-45383</a>	

See Page 43 for More Info

### TYPHOON AIR KIT

Typhoon Air Pumps are easily rebuildable and exceptionally efficient.



- TAKIT0400 Includes: TA400 air pump, 20' x 1/4" flexible tubing, check valve and 4" airstone.
- TAKIT0800 Includes: TA800 air pump, (2) 20' x 1/4" flexible tubing, (2) check valves and (2) 4" airstones.
- Air pumps are completely weatherproof.
- **Limited Warranty:** 3 years.

Air Flow	Max.	Pond Size			
LPM	Depth	Watts	Gallons	Item #	List
6.5	5'	4.5	1,000	<a href="#">ATL-TAKIT0400</a>	
13	5'	9	2,000	<a href="#">ATL-TAKIT0800</a>	

### TYPHOON PUMP

Atlantic's Typhoon Air Pumps feature weatherproof, continuous duty diaphragm compressors specifically designed for year-round usage.



- Easy to clean air filter reduces particulates for motor longevity.
- Aluminum housing radiates and reduces heat to extend diaphragm life.
- **Limited Warranty:** 3 years.

Pump	Watts	Max Depth	Item #	List
TA1800	25	7'	<a href="#">ATL-TA1800</a>	
TA3600	35	11'	<a href="#">ATL-TA3600</a>	

### BLUE DIAMOND AIR PUMPS

Enviro linear air blowers/aerators are designed for use in residential aerobic treatment units/ATU's.



- Specially formulated diaphragm material for extended life.
- Energy efficient motors low power consumption.
- Robust and company construction – weatherproof.

Air Flow	Max. Diffuser	Pond Size			
LPM	Depth	Watts	Gallons	Item #	List
60	4.5'	55	8,000	<a href="#">BD-ET60</a>	
80	4.5'	75	12,000	<a href="#">BD-ET80</a>	
120	6.5'	90	24,000	<a href="#">BD-ET120</a>	

### AQUAOXY AIR PUMP

Check valves enable operation below the water surface level.



- Includes 2 air diffusers and 15' tubing.
- Weather resistant housing.
- **Limited Warranty:** 2 years.

LPM	Max Depth	Watts	Cord	Item#	List
33	8'	25	10'	<a href="#">OAS-50041</a>	

### ROBUST-AIRE AERATION SYSTEMS



\*Large Cabinet System

- No electricity in the water- no restrictions on swimming, boating, or fishing while the unit is operating.
- Easy to maintain. Most maintenance and inspection is performed from shore at the compressor enclosure.
- Energy efficient operation. Robust-Aire circulates the most water with the least energy expended. Robust-Aire™ diffusers produce a superior amount of water flow, exceeding other models by 10 to 40 percent.
- Remote installation. Electrical access near the pond may not be feasible or you simply may want to locate the system away from the pond setting. Air can be delivered to the system from 1/4 mile away.

**Each Kit Contains**

- High Efficiency Piston Compressor.
- Sure-Sink Weighted Tubing.
- Air Diffuser Assembly(s).
- Fittings and Clamps.
- Available in 110 or 240 Volt.

Surface Acres**	# Diffuser Assemblies	3/8" Weighted Tubing	Amps	Item #	List
1.5	1	100'	3.6/1.8	KAS-RA1NC	
3	2	200'	5.4-3.0	KAS-RA2NC	
14.5	3	300'	5.4-3.0	KAS-RA3NC	
8	4	400'	10.9/6	KAS-RA4NC	
10	5	500'	10.9/6	KAS-RA5NC	
11	6	600'	10.9/6	KAS-RA6NC	
				Air Diffuser Only	KAS-772100
				100'-3/8" Weighted Aeration Tubing	KAS-WT100

\*Cabinet (Post- Mount, Large) are optional but compressor needs to be kept in a weather proof ventilated enclosure.

\*\*Robust-Air works most efficiently at depths of 8' and deeper.

**See Page 44 for More Info**

## AIR STONES

	Size	Case	Item #	List
Round	2"	24	<a href="#">BD-D12005</a>	
Disc	4"		<a href="#">BD-D12008</a>	
Disc	6"		<a href="#">BD-D12009</a>	



BD-D12005



BD-D12008-9

## 9" MEMBRANE DIFFUSER

Each diffuser has a minimum of 6,600 engineered air release orifices, which is up to 20% more than comparable others.

- Input: 3/4" MPT.
- 0.5-4 cfm airflow.



Size	Item #	List
9" Disc	<a href="#">FO-FLEX9</a>	

## 24" MEMBRANE DIFFUSER



Tests have shown that EDI membrane diffusers deliver increases of 15 to 50% over competitive products.

- Input: 3/4" MIPT.
- 0-8 cfm airflow.

Size	Item #	List
24" x 2.44 Dia.	<a href="#">FO-ED224</a>	

## STAINLESS STEEL AIR MANIFOLDS

- 1/2" ID x 3/4" OD Inlet.
- 3/16" outlet fits silicone air tubing.



Outlets	Case	Item #	List
6	12	<a href="#">BD-M09006</a>	
8	12	<a href="#">BD-M09008</a>	
12	12	<a href="#">BD-M09007</a>	

## KASCO SMALL DIFFUSER W/ WEIGHTED BASE

Made for shallow water applications, as a replacement or addition to Bantam aeration systems or small diffused aeration system.

Item #	List
<a href="#">KAS-772300</a>	



## OASE OXYTEX DIFFUSER

This unique air diffuser provides the dual benefit of superior air dispersal (oxygenation) and increased surface area (beneficial bacteria growth).

- 9" Dia. x 10" Tall.

Item #	List
<a href="#">OAS-51075</a>	



## Seasonal Diffuser Placement in a Typical Pond

SUMMER DIFFUSER PLACEMENT:

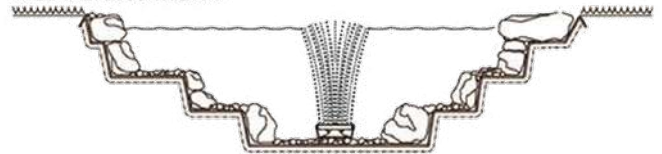

WINTER DIFFUSER PLACEMENT:

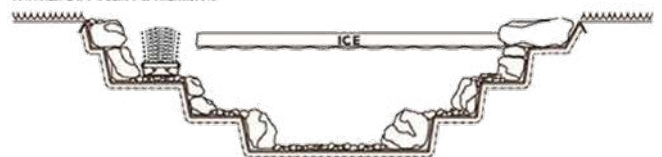

## 1/2" BUBBLER HOSE

Used in both ponds and waste water applications.

- Most efficient in 5'-8' lengths.
- Uses standard poly tubing fittings.
- Fits 1/2" tube fittings.
- 0.5 CFM flow rate.



Type	Item #	List
Per Foot	<a href="#">MDR-750</a>	
200' Roll	MDR-750R	

## WEIGHTED AERATION TUBING

3/8" - Designed to run from compressor to diffusers.

Type	Item #	List
Per Foot	<a href="#">ATL-TPT38</a>	
100' Roll	<a href="#">ATL-TPT38100</a>	



## SILICONE AIR TUBING

Fits 3/16" barb fittings.

Length	Item #	List
100 m / 328'	<a href="#">TUB-SAT100</a>	



## AIR CHECK VALVE

- 3/16" outlet fits silicone air tubing.

Case	Item #	List
12	<a href="#">BD-V01300</a>	





## EASY GARDEN CONTROL THE SMART REVOLUTION

With **OASE EASY GARDEN CONTROL (EGC)** the age begins in which all important functions in and on the pond or in the garden can be centrally controlled via the home network. It enables convenient operation and control of the connected devices with an app via smart phone or tablet.

### AQUARIUS ECO EXPERT

**Brushless DC pump for waterfalls, large decorative fountains, & basalt columns.**

- Powerful, energy efficient pumps for demanding filter systems and fountains.
- Next generation pumps for powerful and economical water delivery.
- Robust stainless steel intake screen passes debris particles up to 3/16".
- Frost protection safeguards pump from freeze damage down to -20°C.
- Integrated grounding plate for unparalleled safety.
- Automatically shuts off the pump in run dry conditions to prevent motor damage.
- Can be regulated and operated remotely either by Eco Control or EGC Controller Cloud.
- Submersed or inline installation in a variety of water types, including chlorinated pool and salt water.
- Dynamic Function Control offers 1 pre-programmed scene, alternating fountain heights, without additional controller; when connected to EGC Dynamic Function Control offers 11 additional pre-programmed scenes.



Max. Flow	Volts	Amps	Watts	Outlet	Max. Head	Cord	Warranty	Item #	List
7300 gph	220-240	2	440	2"	32.8'	33'	5 Year	<a href="#">OAS-57964</a>	
11500 gph	220-240	3.5	700	2"	34.5'	33'	5 Year	<a href="#">OAS-57978</a>	

### AQUAMAX ECO EXPERT

**Powerful, energy-efficient brushless DC filtration pump for large installations.**

- Powerful, energy efficient filtration pumps for demanding filter systems and large waterfalls.
- Next generation pumps suited for extremely powerful and economical water delivery.
- Robust stainless steel intake screen passes debris particles up to 7/16".
- Frost protection safeguards pump from freeze damage down to -20°C.
- Integrated Environmental Function Control automatically shuts off the pump in run dry conditions to prevent motor damage.
- Patented Seasonal Flow Control slows water flow, lowers head height and reduces wattage when temperatures drop in response to lower cool season demand, for up to 50% energy savings (optional).
- Submersed or inline installation in a variety of water types, including chlorinated pool and salt water.
- All functions be regulated and operated remotely by Eco Control and EGC Cloud Controllers.



Max. Flow	Volts	Amps	Watts	Outlet	Max. Head	Cord	Warranty	Item #	List
6800 gph	220-240	2	440	2"	28	33'	5 Year	<a href="#">OAS-57875</a>	
11500 gph	220-240	3.5	700	2"	31	33'	5 Year	<a href="#">OAS-57963</a>	



## PROFICLEAR PREMIUM COMPACT

**Fully automatic, compact-powerful alternative for stocked koi ponds.**

- Drum filters utilize a rotating screen to remove debris and moving bed filtration to strip ammonia and nitrites from the water.
- Fully automatic filter system that offers hands-free operation of even fully stocked koi ponds.
- Pump-fed, flow-through drum filter provides effective cleaning and polishing of water down to 80 microns.
- Drum is fully self-cleaning with a built-in 29 psi high-pressure cleaning pump and automatic 4" waste discharge outlet.
- Moving Bed System with 40 liters of Hel-X Bio-media provides optimal biological filtration capable of decomposing up to 10 oz. of food waste per day.
- Filter capacity can be upgraded by adding an additional 20 liters of Hel-X Bio-media.
- Micro control system offers a choice of manual cleaning, time interval cleaning or full automatic cleaning via sensor.
- Can be buried up to UVC mounts for maximum versatility in filter placement near existing electrical source.
- Pre-installed insulation on the lid ensures quiet operation during cleaning cycles.
- Digital temperature display provides accurate water temperatures for seasonal maintenance.
- Add an optional Bitron C UVC clarifier to either ProfiClear Premium filter system for enhanced clarity and cleaner water.
- Integrated linear air stones provide extra oxygen in the module with included connection kit for AquaOxy 450 (not included).
- Fully control your ProfiClear Compact-M or -L with the Easy Garden Control system from anywhere in the world.

Max. Pond (no fish)	Max. Flow	Volts	Watts	Inlet	Outlet	L x W x H (in)	Warranty	Item #	List
21,000 gal	4000 gph	120	870	2"	4"	35 x 27 x 32	3-Year	<a href="#">OAS-72374</a>	
31,500 gal	5280 gph	120	870	3"	4"	53 x 35.5 x 32.5	3-Year	<a href="#">OAS-73379</a>	

## EGC CONTROLLER CLOUD

**The heart of the Easy Garden Control (EGC) System.**

- Innovative controller for networking EGC devices - controlled via WiFi device.
- Includes 6' EGC connection cable, 6' power cable, end resistor and 110V outdoor transformer, ground stake, and wall-mounting anchor.
- Complete control from anywhere in the world.



Input	Watts	WLAN Range	Warranty	Item #	List
12 volt AC	6	260 ft	3-Year	<a href="#">OAS-72380</a>	

## PROFILUX GARDEN LED RGB

**Simple & economical; Design a colourful sea of LED light.**

- Underwater LED spotlight with RGB illumination effects.
- Suitable for use in and out of the water to a water depth of 13 ft.
- Ideal for illuminating fountains, ponds, and garden landscapes.
- Fast and easy installation. Requires connection to an EGC network.



Light Flux	Beam Angle	Watts	Cord	Item #	List
213 lm	25 degrees	6	16.5 ft	<a href="#">OAS-72377</a>	
<b>Set of 3 - ProfiLux Garden LED RGB Kit</b>					<a href="#">OAS-72376</a>

## PROFILUX GARDEN LED CONTROLLER

Allows the easy connection and control of up to 4 Oase ProfiLux Garden LED RGB Spotlights.



Item #	List
<a href="#">OAS-72378</a>	

## EGC CABLE / CABLE CONNECTOR

Description	Item #	List
2.5 meter Cable	<a href="#">OAS-72381</a>	
5 meter Cable	<a href="#">OAS-72383</a>	
10 meter Cable	<a href="#">OAS-72384</a>	
Cable Connector	<a href="#">OAS-72385</a>	



## BIOPRESS UV PRESSURE FILTER

Compact pressure filter with built-in UV clarifier and cleaning mechanism for small to medium ponds. The BioPress UVC pressure filter incorporates a handle that allows you to compress the filter pads clearing the debris without opening the lid.

- Max Pressure: 7 PSI.
- 1 1/2" MIPT connection.
- 3/4" to 1 1/2" Tubing connections.
- 1" connection on 1000 model.
- **Limited Warranty: 2 years.**



Model	c/w	Max. Pond (no fish)	Recommended Flow	Cord Length	Item #	List
1000	7W UV	1,000	1,050 gph Max.		<a href="#">OAS-45451</a>	
1600	9W UV	1,600	2,000 gph Max.	10'	<a href="#">OAS-40348</a>	
2400	9W UV	2,400	2,120 gph Max.		<a href="#">OAS-45452</a>	

## FILTOCLEAR PRO

The Filtoclear Pro pressure filters combine the convenient cleaning mechanism of the first generation with substantially larger UVs. These larger UVs allow the Filtoclear Pro to filter larger ponds and water gardens with greatly reduced maintenance.

- New backwash feature allows for rinsing and flushing of the UVs quartz sleeve.
- Includes fittings for metric non-kink and 2" PVC flex.
- 2" MIPT connections.
- Most efficient filtration when paired with an Aquamax pump.
- Max Pressure: 7 PSI.
- **Limited Warranty: 2 years.**



Model	c/w	Max. Pond (no fish)	Flow	Cord Length	Item #	List
3000	18W UV	3,000	2,000 gph Max.		<a href="#">OAS-40346</a>	
4000	24W UV	4,200	3,000 gph Max.	15'	<a href="#">OAS-56425</a>	
8000	55W UV	8,000	4,000 gph Max.		<a href="#">OAS-56435</a>	

## VITRONIC UV

OASE's Vitronic UVC provide the best of both worlds, OASE quality at a mid range price.

The Vitronic clears water by eliminating suspended algae (green water) as well as eliminating pathogens and bacteria helping fish health and improving water quality. Can be integrated into an existing system or attached to both the Biosmart 5000 & 10000.

- Hose connection : 1" - 1 1/2".
- Max Pressure: 8 PSI.
- **Limited Warranty: 2 years.**



Vitronic	Max. Pond (no fish)	Flow	Watts	Cord	Item #	List
9	2,500	500 gph Max.	10	10'	<a href="#">OAS-45427</a>	
18	5,000	925 gph Max.	18	16'	<a href="#">OAS-56455</a>	
36	10,000	1,585 gph Max.	36	16'	<a href="#">OAS-40350</a>	

## BIOSMART

The BioSmart is a multi-stage mechanical and biological filtration system in a compact package, designed for medium sized ponds or for watergardens with a moderate fish load.

- Built in venturis on inlets.
- Gravity discharge (75 mm).
- Thermometer included.
- Simple to maintain and clean.
- Service indicators built in.
- **Limited Warranty: 3 years.**



Model	L x W x H	Max. Pond (no fish)	Flow	Item #	List
5000	15" x 22 1/4" x 16 1/4"	4,500	1,500 gph Max.	<a href="#">OAS-56929</a>	
10000	30 1/2" x 22 1/4" x 16 1/4"	9,000	2,200 gph Max.	<a href="#">OAS-56930</a>	

## BIOTEC SCREENMATIC2

These innovative filters offers automatic debris separation using the self-cleaning screen, which separates coarse debris and deposits it in the cleaning tray for easy removal. The BioTec ScreenMatic<sup>2</sup> now has a double-sealed motor and a reinforced screen for an extended service life. The larger sludge basket has been redesigned for greater convenience in the collection and removal of large debris - resulting in reduced contamination of pond water - it prevents sludge water from leaking back into the filter chamber. The BioTec ScreenMatic<sup>2</sup> boasts a bottom drain for easy flushing of the filter.



- New foam design and optimized water level control ensure longer filter service life, improved filtration, and reduced maintenance.
- Intelligent cleaning sensors w/ LED indicator detect the pollutant level and automatically activate the screen.
- Optimized water distributors ensure an ideal water flow over a broad range of pumps- no clogging.
- Rubberized separator lip separates out large debris for better filtration.
- Includes a brush for easy cleaning of the belt filter.
- Features storm-safe fastening clips on each lid ensure safety during heavy winds.
- Limited Warranty: 3 years.

Biotec	L x W x H	Max. Pond (no fish)	Flow	Item #	List
18	31" x 23" x 21"	18,000	4,000 gph Max.	<a href="#">OAS-42975</a>	
24	31" x 23" x 26"	24,000	3,300 gph Max.	OAS-44120	
38	47" x 32" x 30"	38,000	4,623 gph Max.	OAS-42976	

## BITRON-C UV

The UVC technology in Bitron C clarifiers help ensure consistently clear and healthy water by flocculating microscopic green algae that are the main contributors to green and unsightly pond water. Once flocculated, the algae clumps are removed from circulation by the filter.



All Bitron C clarifiers feature bypass technology for optimal water flow regulation past the UV for maximum UV efficiency and built-in automatic glass cleaning.

- Built in bypass valves.
- Specifically designed for use with the Biotec & Biosmart range of gravity filters.
- Built in rotating quartz sleeve de-fouler.
- **Limited Warranty: 2 years.**

Model	Max. Pond (no fish)	Flow	Watts	Cord	Item #	List
55C	18,000	2,100 gph (min) to 7,000 gph (max)	55	15'	<a href="#">OAS-56936</a>	
110C	30,000	3,500 gph (min) to 10,000 gph (max)	110		<a href="#">OAS-57101</a>	

## SMART UV

Designed for pond keepers who appreciate quality and performance but are restricted for space. The SMART UV features a space saving 4" diameter body constructed of UV resistant plastic with a lifetime warranty. Features include T5-style long lasting, low pressure lamps (13 month useful life), protected, "on the cord" power supply and inlets/outlets available with 1 1/2" unions. Each UV is UL and cUL listed.



Watts	Maximum Pond Size	Water Flow Rate Min. / Max.	Lgth x Dia (inches)	Inlet	Cord	Item #	List
18	1,100 Gal	219 GPH / 356 GPH	22" x 4"	1 1/2" Union	16 ft.	<a href="#">PAE-EU18</a>	
25	1,600 Gal	332 GPH / 554 GPH	30" x 4"	1 1/2" Union		<a href="#">PAE-EU25</a>	
40	2,900 Gal	589 GPH / 983 GPH	44" x 4"	1 1/2" Union		<a href="#">PAE-EU40</a>	

\*Life time 4 body warranty on manufacturer's defects and UV deterioration. \*One year warranty on Ballast & 90 days on Lamp.

\*Suggested flow rates are based on "end of lamp's useful life" performance (80% power). \*Mounting clamp not included.

## HIGH OUTPUT UV

HO UVs feature T6 high output hard-quartz glass lamps that produce approximately twice the output watts when compared to standard low-pressure lamps, offering 13 months of continual operation.



Watts	Maximum Pond Size	Flow Rate Min. / Max.	L x D	Inlet	Cord	Item #	List
80	10,800 Gal	2,700 GPH / 3,600 GPH	43" x 5.75"	2" Union	16 ft.	<a href="#">PAE-E80S</a>	
120	13,800 Gal	3,800 GPH / 4,600 GPH	58" x 5.75"	2" Union		<a href="#">PAE-E120S</a>	
150	19,000 Gal	5,040 GPH / 6,360 GPH	70" x 5.75"	2" Union		<a href="#">PAE-E150S</a>	

## SMART HO ML UV (MULTI LAMP UV)

240	21,800 Gal	5,820 GPH / 7,260 GPH	66" x 11"	3" Union	16 ft.	<a href="#">PAE-0250240</a>	
300	36,000 Gal	9,600 GPH / 12,000 GPH	80" x 11"	3" Union		<a href="#">PAE-0250300</a>	

## REPLACEMENT LAMPS

	Base	W	Length	Item #	List
Smart UV Lite	T5F	18	14.50	<a href="#">PAE-FL2536IP</a>	
Smart UV Lite	T5F	25	18.50	<a href="#">PAE-FL2542IP</a>	
Smart UV Lite	T5F	40	33.50	<a href="#">PAE-FL1957IP</a>	
Smart UV 65/130	T5F	65	61.75	<a href="#">PAE-FL2529IP</a>	
Smart HO	T5F	50	18.50	<a href="#">PAE-FL2538IP</a>	
Smart HO	T5F	80	33.50	<a href="#">PAE-FL2997IP</a>	
Smart HO 120/240	T5F	120	45.125	<a href="#">PAE-FL2998IP</a>	
Smart HO 150/300	T5F	150	60.75	<a href="#">PAE-FL2999IP</a>	
	Base	W	Length	Item #	List
Compact Skimmer UV	T5F	16	14.50	<a href="#">PAE-FL2725IP</a>	
Skimmer UV Clarifier	T5F	25	17.50	<a href="#">PAE-FL2542IP</a>	
Skimmer UV Clarifier	T5F	57	17.50	<a href="#">PAE-F3217PL2IP</a>	
	Base	W	Length	Item #	List
	G23	5	4	<a href="#">PUV-H2305</a>	
Filtral 700, Biopress 1000	G23	7	5.35	<a href="#">PUV-H2307</a>	
Filtoclear (Old Style), Filtral 1200, Biopress 1600, Biopress 2400, Biosmart 1600, Vitronic 9	G23	9	6.50	<a href="#">PUV-H2309</a>	
	GX23	13	7.25	<a href="#">PUV-HX213</a>	
Bitron 18 UVC, Vitronic 18, Filtoclear 3000	2G11	18	8.75	<a href="#">PUV-G1118</a>	
Bitron 24 UVC, Filtoclear 4000	2G11	24	12.00	<a href="#">PUV-G1124</a>	
Bitron 36/72(2) UVC, Vitronic 36	2G11	36	16.00	<a href="#">PUV-G1136</a>	
Bitron 55/110(2) UVC, Filtoclear 8000	2G11	55	21.00	<a href="#">PUV-G1155</a>	

## QUARTZ SLEEVE (1" DIA.)

Watts	Length	Item #	List
18	17.25"	<a href="#">PAE-FLQZ1731P</a>	
25 & 50 HO	23.25"	<a href="#">PAE-FLQZ1751P</a>	
40 & 80 HO	38.25"	<a href="#">PAE-FLQZ1761P</a>	
65 & 150 HO & 300 HOML	65.0"	<a href="#">PAE-FLQZ1671P</a>	
120 HO & 240 HOML	50.75"	<a href="#">PAE-FLQZ1651P</a>	

## POWER SUPPLY

Includes cord seal, 4-pin connector and grey bushing and lock ring.



Watts	Voltage	Item #	List
12 - 40 Smart-UV Lite 50 & 65w	115	<a href="#">PAE-20120MV</a>	
50 HO	115	<a href="#">PAE-20105MV</a>	
80 HO & 120 HO	115	<a href="#">PAE-2021501</a>	
150 HO	115	<a href="#">PAE-2021501</a>	

## SERVICE KIT

Includes Gaskets & O-Rings.



Watts	Item #	List
12 - 65 Smart UV	<a href="#">PAE-P20375</a>	
50/80/120/150 HO UV	<a href="#">PAE-P203752</a>	
4 Pin Lamp Connector	<a href="#">PAE-P7091S</a>	

## MOUNTING CLIPS



Size	Item #	List
2"	<a href="#">PAE-CP10A</a>	
3"	<a href="#">PAE-CP12A</a>	



## SNORKEL VAULT & CAP

### A Field-Tested, Field-Proven System for Filtering Large Bodies of Water

The patented Snorkel Vault and Centipede Module were specifically designed to tackle any number of the common issues that plague large scale water features. They are modular in design, allowing builders and designers the flexibility to expand the system to meet their needs.

- Highly effective at removing sediment (suspended solids) from the pond.
- Easily access collected sediment with the Snorkel Vault, reducing the need for costly and invasive dredging.
- Improves water clarity.
- Works on earth bottom and liner membrane ponds.
- Strips excess nutrients from the water column, reducing algae and the physical and chemical maintenance that goes along with removing algae.
- Easily retrofitted onto existing ponds.
- Create a waterfall and stream by designing the wetland filter system off the perimeter of the pond.



Item # List

[AQS-29064](#)

## LARGE CENTIPEDE MODULE



Item # List

[AQS-29065](#)

## SNORKEL VAULT EXTENSION

- For use when creating deeper basins. Also required when using the Aquascape PRO 10,000 or 12PN pump



Item # List

[AQS-29068](#)



## AQUABLOX SMALL WATER STORAGE MODULE

The AquaBlox D-Raintanks module is a lightweight structure that provides area or void space for various water storage projects and water features. Each small AquaBlox is able to hold up to 17 gallons of water and will support up to 5,472 lbs/ sq. ft. when properly installed with geotextile underlayment and EPDM pond liner.

- Over 3 times more water storage capacity than gravel.
- Extra water storage capacity means less time topping off reservoir due to evaporation.
- Easier to clean and less prone to clogging than traditional gravel basins
- The ability to hold more water per cubic foot allows for smaller reservoir footprint.
- Assembly is quick and easy, less than 1 minute per unit.
- **Size:** 26.5" L x 16" W x 9.5" H

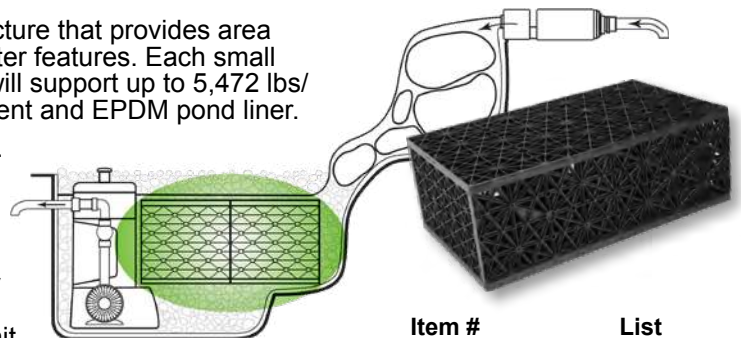

Item # List

[AQS-29491](#)

## FLO-CELL 30MM DRAINAGE CELL

Facilitate adding roof top gardens and planter boxes to building construction without adding heavy aggregate as drainage. Provides a structurally strong structure, highly effective drainage, and lightweight properties.

Item # List

[AQS-94012](#)

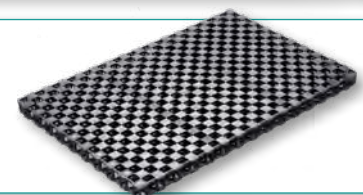

## PONDLESS WATERFALL VAULT

The ideal pump vault for use in Pondless Waterfalls, rainwater harvesting systems, and more. Designed to integrate with Aquascape AquaBlox, effectively protecting pumps while making installation quick, precise, and simple. Its durable, rotationally-molded, rounded polyethylene shape maximizes structural strength, while its large interior fits a wide range of pump sizes up to 12,500 gallons per hour. The vault's extra-wide opening makes it easy to access the interior of the vault for pump maintenance. Includes a durable lid with a built-in water level inspection port, allowing the vault easily camouflaged and out of sight.



### VAULT EXTENSION

The Pondless Waterfall Vault Extension slides onto the Pondless Waterfall Vault increasing the height for deeper basins using the Large AquaBlox.



Description	L x W x H	Item #	List
Pondless Waterfall Vault	23" x 17" x 25.5"	<a href="#">AQS-49000</a>	
Vault Extension	16" x 16" x 9"	<a href="#">AQS-49001</a>	

## PROFESSIONAL GRADE POND KITS

Aquascape Pond Kits come complete with everything you need to build a beautiful ecosystem pond in any space. All necessary components are provided in a convenient, all-in-one kit that takes the guesswork out of purchasing individual components. The included skimmer and BioFalls filter provide efficient mechanical and biological filtration, allowing you to spend more time enjoying your pond. A complete LED lighting package is included to help bring the waterfall to life at night. The kit also includes the Automatic Dosing System for Ponds with water treatment, automatically adding water treatments to the pond when needed.



Model / Item #	Medium - 11' x 16' AQS-53034	Large - 21' x 26' AQS-53036
Skimmer	Signature Series 1000	Signature Series 1000
BioFalls	Signature Series 2500	Signature Series 2500
Pump	AquaSurge 2000-4000 Adjustable Flow	AquaSurge 4000-8000 Adjustable Flow
Pipe	Flexible PVC 2" x 25'	Flexible PVC 2" x 50'
Liner Material	45 mil EPDM (Fish Safe)	45 mil EPDM (Fish Safe)
Liner Size	15' x 20'	25' x 30'
L x W x Max Depth	11' x 16' x 2'	21' x 26' x 2'
Underlayment	300 sq ft	750 sq ft

Item # [AQS-53034](#) List



Item # [AQS-53036](#) List

## SMALL PONDLESS WATERFALL KIT - 6' STREAM

Comes complete with everything you need to build a beautiful, one-of-a-kind, recirculating 6' waterfall and stream in any space, eliminating the guesswork and calculations when purchasing individual components. Connect the included energy-efficient pump to the Aquascape Smart Control App to schedule and adjust flow with your smartphone or tablet. An LED lighting package is included to bring your pond to life at night.

### Includes:

- Waterfall Spillway 22"
- Pondless Waterfall Vault
- (3) AquaBlox Small Water Storage Modules
- AquaSurge 2000-4000 Adjustable Flow Pond Pump w/ check valve assembly
- Automatic Dosing System for Fountains with 32 fl. oz. water treatment
- All necessary installation materials.



Item # [AQS-53038](#) List

## SIGNATURE SERIES POND SKIMMERS

The Aquascape Signature Series 400 & 1000 Pond Skimmers provide efficient mechanical filtration by removing unwanted debris from the surface of the pond, significantly reducing maintenance and improving water quality. The filter also provides a protected location for the pump, extending pump life. Ideal for ponds up to 400 or 1000 square feet.

Model / Item #	Series 400 AQS-43021	Series 1000 AQS-43022
Pond Size	Up to 400 sq. ft.	Up to 1000 sq. ft.
Pump Flow Rate	Up to 4,000 GPH	Up to 10,000 GPH
Weir Size	6"	8"
L x W x H	21.5" x 18" x 21"	21" x 22" x 26.5"



Item #	List
<a href="#">AQS-43021</a>	
<a href="#">AQS-43022</a>	

## SKIMMERS

Features heavy-duty components that stand up to years of use. Equipped with Super Flow weir doors, debris net and oversized brush panels that reduce maintenance. Lifetime Warranty.

- Sturdy removable top lid supports natural rock camouflage and foot traffic.
- Heavy-duty brush panel provides maximum surface area for mechanical filtration.
- Heavy-duty SS framed trap net for catching large debris.
- Rolled upper rim provides clean lines and incredible strength.
- Super Flow weir door for maximum surface cleaning.
- High-density polyethylene shell for the ultimate in durability.

Weir Size	GPH Flow	W x D x H	Item #	List
6"	4,000	20" x 26" x 22"	<a href="#">ATL-PS4600</a>	
9"	7,000	25" x 30" x 24"	<a href="#">ATL-PS7000</a>	
14"	15,000	28" x 33" x 31"	<a href="#">ATL-PS15000</a>	



## OASIS SKIMMER

- Sturdy removable lid supports natural rock camouflage and foot traffic.
- Rolled upper rim provides clean lines and incredible strength.
- Stainless steel framed trap net and Matala filter mat provide exceptional mechanical filtration.
- Pump discharge step fittings for 1.5" & 2" pipe on both sides.
- Labeled drill points for the Auto Fill and overflow.

Weir Size	GPH Flow	W x D x H	Item #	List
6"	3,900	17.75" x 19.5" x 19.5"	<a href="#">ATL-PS3900</a>	



## SATELLITE SKIMMER

Atlantic Pro-Series Satellite Skimmer draws and cleans water from hard-to-reach areas of a pond, the Satellite Skimmer is used in combination with (and plumbs into) the main pond skimmer.

- Installs inside or outside the pond.
- Use with Skimmer: PS7000 or PS15000.

Weir Size	GPH Flow	W x D x H	Item #	List
6"	3,000	13" x 13" x 25"	<a href="#">ATL-PS3000</a>	



## AQUASKIM IN-POND SKIMMER

Effectively removes leaves and other debris the pond surface. Automatically adjusts to a drop in water level (up to 6 in). Ideal retrofit for existing ponds.

- 1 1/2" MIPT connection.
- For use with Aquamax Eco Premium

Surface	Flow Range	Item #	List
270 sq/ft	1,600 - 4,700 GPH	<a href="#">OAS-57395</a>	



## FILTERFALLS

Professional water garden contractors demand the latest technology and highest quality. This product has all the attributes that make large-scale professional installations easy and successful.

- Heavy-duty removable top grate allows natural rock camouflage.
- Support bars add stability and reinforce top grate.
- Dual Bio-Tech filter mats for exceptional biological filtration.
- Sturdy bottom grate supports filter media.
- Rolled upper rim provides clean lines and incredible strength.
- Solid lip and molded-in inserts ensure a watertight liner attachment.
- Bottom chamber accepts bulkheads on all sides while bottom cones reduce surface area for more efficient back flushing.
- One-piece liner flange allows easy, leak-free attachment to pond liner.
- 1 1/2" (BF1600), 2" or 3" heavy-duty FIPT bulkheads for high flow rates.



Spillway	Max Flow	W x D x H	Item #	List
16"	3,000 GPH	21.5" x 19.5" x 17.75"	<a href="#">ATL-BF1600</a>	
19"	4,000 GPH	28" x 25" x 21.5"	<a href="#">ATL-BF1900</a>	
26"	6,000 GPH	34.5" x 25" x 23"	<a href="#">ATL-BF2600</a>	
38"	8,000 GPH	46.5" x 30" x 23"	<a href="#">ATL-BF3800</a>	

## FASTFALLS

These incredibly strong one-piece units feature an internal baffling system, support cones and a reinforced spillway. The 'inside the liner' design plus rear liner attachment simplifies installation and eliminates leaking. The top can be covered with rock, gravel, soil or mulch to blend seamlessly with the surrounding landscape.



- Raised front radius holds back any loose gravel, soil or mulch used to camouflage the top of the unit.
- Connection 19" & 26" - 2", 38" - 3".

L x W x H	Spillway	GPH Flow	Item #	List
9.5" x 16.5" x 7.25"	16"	3,000	<a href="#">ATL-SP1600</a>	
20.5" x 17" x 10.25"	19"	4,000	<a href="#">ATL-SP1900PRO</a>	
27.5" x 17" x 10.25"	26"	6,000	<a href="#">ATL-SP2600PRO</a>	
39.5" x 17" x 10.25"	38"	9,000	<a href="#">ATL-SP3800PRO</a>	



## 8" WATERFALL SPILLWAY

Can be used to decorate your outdoor space, as it allows you to easily create a disappearing water feature.



Max Flow	Fits Tubing	Item #	List
1,250 GPH	3/4", 1"	<a href="#">PB-DWFB</a>	

## 16" WATERFALL SPILLWAY

Easy to install and adds a dramatic effect. Mounts to any liner and is made with durable UV resistant high impact plastic with connections on the back for tubing.



Contains additional filtration with bio balls, filter foam, and locking rock tray.

Spill Way	Max. GPH Flow	Fits Tubing	Item #	List
16"	3,750	1", 1 1/2"	<a href="#">PB-DWF16</a>	

## WATERFALL SPILLWAYS

Ranging from 14" to 36", all come retail-ready with bulkhead, liner attachment flange, splash reduction foam, and top grate for easy camouflaging.

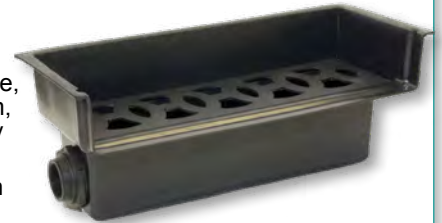

- Lifetime Warranty on shell.

Spillway	GPH Flow	Item #	List
14"	2,000	<a href="#">ATL-SP1400</a>	
25"	4,000	<a href="#">ATL-SP2500</a>	
36"	6,000	<a href="#">ATL-SP3600</a>	



## 12" WATERFALL SPILLWAY

Easily create a waterfall or stream, providing smooth, consistent, leak-free water flow. The spillway is extremely versatile and durable and can be used in a wide variety of water feature applications. Its design allows boulders, gravel, soil, or other creative landscape material to be set directly on top, making it easy to camouflage into the surrounding landscape.



Max. Flow	Fittings	Item #	List
4,000 GPH	2" PVC slip, 1.5" barbed	<a href="#">AQS-77023</a>	

## SIGNATURE SERIES 2500 BIOFALLS FILTER

Ideal for filtering ponds up to 2,500 gallons, and providing efficient biological and mechanical filtration. Its durable, rotationally-molded, rounded polyethylene shape maximizes structural strength while making it easier to camouflage. Can handle flow rates up to 5,000 GPH, the filter can be installed in a wide variety of applications.



Spill Way	Max. GPH Flow	Fittings	Item #	List
21.5"	5,000	(2) 2" PVC slip	<a href="#">AQS-09020</a>	

## COLORFALLS

The Colorfalls have been specifically designed to work with most retaining walls to add a beautiful sheer waterfall. The units boast low energy LED lights, an extra long reinforced weir, and an interior baffling system that produces a single lighted water sheer. Enjoy the sights and sounds of soothing lighted falls in your next outdoor project.



Color	W x D x H	GPH Flow	Watts	Item #	List
Ice Blue	12"x8"x3-1/2"	1000	3	<a href="#">ATL-CF12B</a>	
Fire Red				<a href="#">ATL-CF12R</a>	
Crystal White				<a href="#">ATL-CF12W</a>	
Sol White				<a href="#">ATL-CF12SW</a>	
Ice Blue	24"x8"x3-1/2"	2000	6	<a href="#">ATL-CF24B</a>	
Crystal White				<a href="#">ATL-CF24W</a>	
Sol White				<a href="#">ATL-CF24SW</a>	
Ice Blue	36"x8"x3-1/2"	3000	9	<a href="#">ATL-CF36B</a>	
Fire Red				<a href="#">ATL-CF36R</a>	
Crystal White				<a href="#">ATL-CF36W</a>	
Sol White				<a href="#">ATL-CF36SW</a>	



## COLOR CHANGING COLORFALLS

Create brilliant effects with Atlantic's completely redesigned Color Changing Colorfalls. The new weir style creates a thicker, fuller sheer that adds body and extra color to your falls with less wind deflection, and the modular design allows custom spillways of any width! The light bar offers 48 vibrant color options and patterns via remote control, and an optional Master Controller will synchronize the displays of up to five units, separate or connected. Stand out from the crowd!

W x D x H	GPH Flow	Watts	Item #	List
6" x 8" x 3-1/2"	600	6	<a href="#">ATL-CCCF06</a>	
12" x 8" x 3-1/2"	1,200	8	<a href="#">ATL-CCCF12</a>	
24" x 8" x 3-1/2"	2,400	10	<a href="#">ATL-CCCF24</a>	
36" x 8" x 3-1/2"	3,600	12	<a href="#">ATL-CCCF36</a>	



### Master Controller

Synchronize up to five individual Color Changing Colorfalls 80 Watts [ATL-CCCM05](#)

## BASIN KITS

Atlantic Basin Kits are designed to fit perfectly with all formal spillways - the Color Changing Colorfalls, the Classic Colorfalls and Stainless Steel/Copper Scuppers. Whether you're adding the shimmering night time enchantment of a Colorfalls or an elegant touch of class with a Stainless Steel Scupper our Basin Kits provide everything you need to complete the installation.

**Basin Kits Include:** Colorfalls Basin & TT Pump, 1/2" x 10' Flexible PVC Pipe, Splash Mat, AF1000 Auto Fill, Complete Installation Kit including pump discharge, flow valve, spray glue and thread sealant.

**12"**  
Use with all 12" spillways

- TT1500 Pump.
- CFBASIN12.

Item #	List
<a href="#">ATL-CFBASINKIT12</a>	

**24"**  
Use with all 24" spillways

- TT3000 Pump.
- CFBASIN24.

Item #	List
<a href="#">ATL-CFBASINKIT24</a>	

**36"**  
Use with all 36" spillways

- TT4000 Pump.
- CFBASIN36.

Item #	List
<a href="#">ATL-CFBASINKIT36</a>	



## DH Line

### STAINLESS STEEL TROPICAL FALLS

Add beautiful waterfalls into any hardscape design using DH Line's **Stainless Steel Tropical Falls!** Constructed of quality stainless steel for strength and corrosion resistance. Featuring cool white LED lighting, it will add a striking touch and subtle presence to formal and casual settings alike.

Length	Watts	Item #	List
12"	1.3	<a href="#">DH-10013SS</a>	
24"	2	<a href="#">DH-10025SS</a>	
36"	4.2	<a href="#">DH-10036SS</a>	
48"	5.1	<a href="#">DH-10048SS</a>	
60"	5.6	<a href="#">DH-10060SS</a>	



## SCUPPERS

Atlantic's Stainless Steel and Copper Finish Scuppers bring a gleaming dimension to our spillway line. The Stainless constructed of durable 304 stainless steel and both are available in the same sizes as the popular Colorfalls, these sleek modern scuppers put a sharp fresh shine on your formal water feature project.

- 5" lip extension.
- 1 1/2" FIPT inlet on the back.



Stainless Steel				
W x D x H	GPH Flow	Inlet	Item #	List
12" x 8 1/2" x 4"	1,200	1 1/2"	<a href="#">ATL-SS12</a>	
24" x 8 1/2" x 4"	2,400	1 1/2"	<a href="#">ATL-SS24</a>	
36" x 8 1/2" x 4"	3,600	1 1/2"	<a href="#">ATL-SS36</a>	

Copper Finish				
W x D x H	GPH Flow	Inlet	Item #	List
12" x 8 1/2" x 4"	1,200	1 1/2"	<a href="#">ATL-CS12</a>	
24" x 8 1/2" x 4"	2,400	1 1/2"	<a href="#">ATL-CS24</a>	
36" x 8 1/2" x 4"	3,600	1 1/2"	<a href="#">ATL-CS36</a>	



## ANTI SPLASH MAT ROLLS

One issue with architectural features is the splash that occurs from the falling water from a sheer descent spill way or spout. Anti-Splash Mat is designed to control splash resulting in a cleaner look without losing water.



Size	Item #	List
28" x 10'	<a href="#">ATL-CFSPMA2810</a>	
28" x 20	<a href="#">ATL-CFSPMA2820</a>	

## SPLASH RING

Stainless Steel and Copper Finish Splash Rings tame errant droplets and complement all of our formal spillways.



Use With Basin	Stainless Steel		
	W x D x H	Item #	List
ATL-CFBASIN12	16" x 8" x 1 1/2"	<a href="#">ATL-CFSR12</a>	
ATL-CFBASIN24	28" x 8" x 1 1/2"	<a href="#">ATL-CFSR24</a>	
ATL-CFBASIN36	40" x 8" x 1 1/2"	<a href="#">ATL-CFSR36</a>	

Use With Basin	Copper Finish		
	W x D x H	Item #	List
ATL-CFBASIN12	16" x 8" x 1 1/2"	<a href="#">ATL-CFCR12</a>	
ATL-CFBASIN24	28" x 8" x 1 1/2"	<a href="#">ATL-CFCR24</a>	
ATL-CFBASIN36	40" x 8" x 1 1/2"	<a href="#">ATL-CFCR36</a>	

## WALL SPOUTS

These solid brass spouts add old world charm with a modern twist.

- Solid brass fixtures with oil rubbed bronze or antique copper finish.
- 1 1/2" inlet for smooth water flow.
- Integrated drip edge to eliminate backflow down the wall.
- Projection: 14-16" at 18" & 600 GPH.



Flow Rate	Dimensions		Bronze Item #	List
	W	D x H		
600 GPH	5"	4 3/4" x 5"	<a href="#">ATL-WSMS</a>	
600 GPH	5"	5 3/4" x 6"	<a href="#">ATL-WSRO</a>	
600 GPH	7"	4 3/4" x 7"	<a href="#">ATL-WSVS</a>	
600 GPH	6"	4 1/2" x 5"	<a href="#">ATL-WSOO</a>	

Flow Rate	Dimensions		Copper Item #	List
	W	D x H		
600 GPH	5"	4 3/4" x 5"	<a href="#">ATL-WSCMS</a>	
600 GPH	5"	5 3/4" x 6"	<a href="#">ATL-WSCRO</a>	
600 GPH	7"	4 3/4" x 7"	<a href="#">ATL-WSCVS</a>	
600 GPH	6"	4 1/2" x 5"	<a href="#">ATL-WSCOO</a>	

## SPOUT LIGHTS

SOL LED (1" MIPT)			
Cord	Watts	Item #	List
20'	2	<a href="#">ATL-WWSL2</a>	

Colour Changing LED (1" MIPT)			
Cord	Watts	Item #	List
20'	1 - 2.5 Variable	<a href="#">ATL-CCSL2</a>	

See Page 31 for More Into





## 30" COPPER BOWL W/ 4" SPILLWAY

- Crafted out of solid copper.
- Can be used alone as a decorative accent in fountains or ponds or to start a waterfall.
- Designed to form a natural patina over time.



GPH Flow	Inlet	W x D x H	Item #	List
750	(2) 1 1/2" FITP	30" x 33" x 14.5"	<a href="#">ATL-CB30R4</a>	

## 36" COPPER BOWL

- Designed to overflow around its entire perimeter into either a Fountain Basin or an Eco-Rise System.
- Dual 1" FIPT inlets and standpipe for lighting and water supply.
- Dual inlets allow water supply to be plumbed independently from lighting cords.



GPH Flow	Inlet	W x H	Item #	List
2400	(2) 1 1/2" FITP	36" x 14.5"	ATL-CB36R0	

## 26" COPPER BOWL W/ [4] 6" SPILLWAYS

- Crafted out of solid copper.
- Features four 6" spillways, dual 1" FIPT inlets and standpipe for lighting and water supply.



GPH Flow	Inlet	W x D x H	Item #	List
2400	(2) 1 1/2" FITP	29" x 29" x 10"	ATL-CB26R6	

## COPPER PEDESTAL FOR COPPER BOWLS

- Pedestal of solid reinforced copper is designed to securely elevate all Copper Fountain Bowls and Copper Spillway Bowls by 8"



W x D x H	Item #	List
16" x 16" x 8"	ATL-CB16P	

## 26" SQUARE COPPER BOWL W/ 12" SPILLWAY

- Crafted out of solid copper.
- Dual 1 1/2" FIPT inlets and solid copper standpipe for lighting and water supply.



GPH Flow	Inlet	W x D x H	Item #	List
1200	(2) 1 1/2" FITP	26" x 27.5" x 10"	ATL-CB26S12	

## 26" ROUND COPPER BOWL W/ 12" SPILLWAY

- Crafted out of solid copper.
- Pedestal accessory allows bowls to be elevated 8".
- Designed to work with the CFBASINKIT12.



GPH Flow	Inlet	W x D x H	Item #	List
1200	(2) 1 1/2" FITP	26" x 27.5" x 10"	<a href="#">ATL-CB26R12</a>	

Copper Bowls lend themselves to a number of lighting options. Spotlights are a great way to accent water overflowing the 36" Copper Bowl or the concentrated flow from spillways. Inside the bowl, the submersible Ring Light creates rippling uplighting effects on overhanging trees or structures. Atlantic's unique Cord Seal Fitting makes lighting inside the bowl possible without a visible cord coming over the edge. The rubber fitting installs inside one of the two 1 1/2" FIPT inlets, and when tightened expands, sealing the cord and the inlet.



## SPILLWAY BOWL AND BASIN LANDSCAPE FOUNTAIN KIT

The perfect combination of products, providing a unique, easy-to-install kit that includes everything you need to create an impressive recirculating fountain. The included Spillway Bowl and Spillway Basin are constructed of durable GFRC and display a unique patina finish, providing a long-lasting, elegant, multi-step fountain ideal for any setting.

- Kit includes everything needed for installation.
- Creates an impressive multi-step fountain.
- Eliminates guesswork of selecting products individually.
- Simple design makes installation quick and easy.
- Includes spillway basin, spillway bowl, spillway stands, water basin, pump, and pipe
- Able to store up to 98 gallons of water,



Item #	List
<a href="#">AQS-58087</a>	

## MEDIUM STACKED SLATE URN LANDSCAPE FOUNTAIN KIT

The perfect combination of products, creating an easy-to-install fountain kit that includes everything you need for an impressive recirculating fountain. The urn's durable fiber-resin composite construction provides all of the natural beauty of real rock with the added benefits of fiber-resin.

- Kit includes everything needed for installation.
- Creates an impressive, natural-looking stacked slate urn fountain.
- Eliminates guesswork of selecting products individually.
- Simple design makes installation quick and easy.
- Includes fountain, water basin, pump, and pipe
- Able to store up to 98 gallons of water,



Item #	List
<a href="#">AQS-58090</a>	

## MEDIUM STACKED SLATE SPHERE LANDSCAPE FOUNTAIN KIT

A complete kit that makes it easy to add the relaxing sights and sounds of water to any location. The lightweight, durable fiber-resin composite fountain construction is built to last and provides the look and beauty of real rock. Water is pumped up through the center of the fountain and gracefully cascades over the stacked slate texture, creating an impressive effect.

- Complete kit creates an impressive, natural-looking fountain.
- Lightweight, durable fiber-resin composite construction, gives the appearance of real stone.
- Ideal for a wide variety of installation locations.
- AquaBasin® 45 fountain basin, plumbing, and Ultra 1500 Water Pump included.



Description	Item #	List
Medium Slate Sphere Kit	<a href="#">AQS-78290</a>	
Large Slate Sphere (Sphere Only)	<a href="#">AQS-78289</a>	

## PATIO PONDS

Aquascape Patio Ponds make it simple to have a complete water garden in any setting without ever having to touch a shovel. The integrated plant shelf and plumbing ports makes creating a beautifully planted container water garden easier than ever. The durable fiber-resin construction is lightweight and built to last. Aquascape Patio Ponds can be used to transform any outdoor or indoor environment and the natural finish allows the feature to blend easily into a wide variety of settings.

- Makes it simple to have a water garden in any setting.
- Integrated plant shelf and plumbing ports.
- Durable fiber-resin construction.
- Can be used indoors or outdoors.



Green Slate

European Terra Cotta



Description	Item #	List
Green Slate	<a href="#">AQS-98856</a>	
European Terra Cotta	<a href="#">AQS-98858</a>	



## PUMP VAULTS

The heavy duty one piece design of Atlantic's Pump Vault can accommodate large pumps and flow rates up to 15,000 GPH. Features include large openings for pump access, cut lines for pump and flat panels for custom discharge and pipe extensions, plumbing applications.



- Stronger, high density polyethylene.
- Pre-drilled for 2" discharge pipe.

Max Pump Flow	Dimensions W x H	Item #	List
10,000	18" x 24"	<a href="#">ATL-PV1800</a>	
15,000	23" x 30"	<a href="#">ATL-PV2300</a>	
Extension 16.5" x 19.5"		<a href="#">ATL-PV18EXT</a>	
Extension 21.5" x 19.5"		<a href="#">ATL-PV23EXT</a>	

## OASIS PUMP VAULT

- Inset lid keeps gravel from falling into the vault.
- Pump discharge step fittings for 1½" & 2" pipe provided on both sides of the vault.
- Flat front panel installs tight against the Eco-Blox for a compact basin.
- Recessed pockets accept Triton 3-Way Diverter for use with the Eco-Rise.
- Flat panel for 1½" pipe for use with the Eco-Rise.
- 10" Access lid.



Max Pump Flow	Dimensions L x W x H	Item #	List
3,900 GPH	12" x 17" x 22 1/2"	<a href="#">ATL-PV1700</a>	

## ECO-BLOX

The redesigned Eco-Blox provides the same amount of storage, with improved strength and durability. The new triangle-shaped openings allow for greater water mobility while preventing solids from slipping through.

- Holds 3X more water than gravel pits.
- 8 panel construction for exceptional strength.
- 31.5 Gallons water storage.

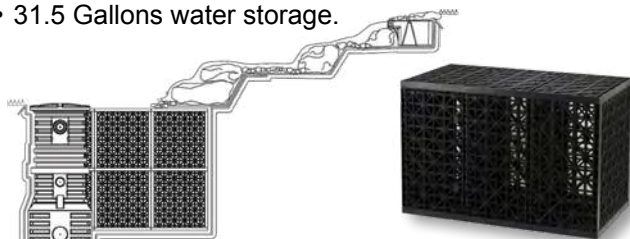

Capacity	Dimensions L x W x H	Item #	List
31.5 gal	27.5" x 16" x 17.5"	<a href="#">ATL-ECOBLOX</a>	

## ECO-RISE

The extremely strong radial structure handles the weight of heavier statuary, vases and columns while providing a broad stable base over Eco-Blox reservoirs. The versatility of the Eco-Rise used in conjunction with Eco-Blox, PV1700 Pump Vault and Triton 3-Way Diverter allows for multiple features in any configuration above odd basin shapes, while keeping plumbing and flow adjustment topside for easy access.



Max Load	Max Plumbing Size	Dimensions L x W x H	Item #	List
3000 lbs	1 1/2"	20" x 20" x 3"	<a href="#">ATL-ECORISE</a>	

## TRITON 3 IONIZER

Atlantic's modular design is at the cutting edge of innovation, with tool-less, seamless integration with our award-winning Triton Check Valve! Safe for animals and plants and unaffected by sunlight and heat, this mineralized water maintains a residual ability to treat organics, greatly reducing the need for chemical treatments.

- Clears water without the use of harsh chemicals.
- Easily installed in any new or existing water feature.
- Level of mineralization is controlled by the LED panel.
- **Limited Warranty:** 3 years.
- Safe for fish and plants.
- Treats ponds up to 25,000 gallons.
- Includes outdoor transformer and copper test kit.



Voltage	Wats	Inlet	Item #	List
12	2	2"	<a href="#">ATL-TRION3</a>	
Replacement Anode (Triton 2)			<a href="#">ATL-TRION2RA</a>	

Item #	List
Replacement Anode (Triton)	<a href="#">ATL-TRIONRA</a>
Copper Test Strips	<a href="#">ATL-TRIONTS</a>

Can be controlled via a smartphone using Triton Ionizer App



## ATLANTIC WATER WALL SPILLWAYS

- Vertically oriented spillway simplifies the construction of water walls, weeping wall and rain curtains.
- Revolutionary concept of spillway as a decorative focal point eliminates the need for valances.
- Heavy-gauge 316 stainless steel construction ensures durability under even the harshest conditions.
- Bottom inlet accommodates wood-framed or masonry walls with facades up to 1 1/2" thick.
- 1 1/2" female threaded inlet and center rear bonding lug facilitate hidden in-wall plumbing connections.
- Flow Rate smooth (surfaces) 750-1,500 GPH
- Flow Rate smooth (rough) 1,500-3,000 GPH
- Stainless Steel or Copper Finish.
- Dimensions: 24"W x 5 1/4"D x 3 1/2"H
- 3 Year Warranty.



	Item #	List		Item #	List
<b>Stainless Steel</b>	<a href="#">ATL-SWS24</a>		<b>Copper</b>	<a href="#">ATL-CWS24</a>	



2400

3200 & 4600

## PRO SERIES FOUNTAIN BASIN

When they were introduced, Atlantic Fountain Basins were already the strongest and best-designed on the market, featuring deep plumbing channels on top of the basins, easy access pump chambers and external flow adjustment for convenient installation and maintenance. Now they're even better, with new internal buttressing cones for greater rigidity.



- 1) One-piece construction provides exceptional strength.
- 2) Built-in channels simplify installation, allowing the plumbing to be run on top of the basin.
- 3) Molded cones support the top panel.
- 4) Recessed pocket accepts Triton 3-Way Diverter (FB4600 only). Adjusting the water flow to multiple pieces has never been easier.
- 5) 1 1/2" conduit recesses allow for clean installation in surrounding masonry without notching.
- 6) Flat panel for optional Auto Fill installation.

Load	Dimensions	Capacity	Item #	List
200 lb	24" x 10"	20 gal	<a href="#">ATL-FB2400</a>	
600 lb	32" x 13"	32 gal	<a href="#">ATL-FB3200</a>	
1,200 lb	46" x 13"	67 gal	<a href="#">ATL-FB4600</a>	

## 3-WAY VALVE 1/2" MPT X 3/4" BARBED

- Ease of installation in many uses.
- 3 way valve allows you to control or shut-off the flow of each output with a simple knob.



Item #	List
<a href="#">AQS-88025</a>	

## TRITON 3 WAY DIVERTER

True 'ball' style valves with removable handles enable small flow adjustments to be made to each outlet independently.



Inlet	Outlet	Item #	List
1 1/2" FIPT	(3) 3/4" Insert	<a href="#">ATL-TR3WAY</a>	

## FOUNTAIN BASIN PLUMBING KIT

- Kits include everything needed, from valves to fittings, reducing installation time.
- Single and triple adjustment valves are located above water level, for greater comfort and convenience.



Kit	Pump Flow Size	Item #	List
1 Piece	200-500 GPH	<a href="#">ATL-FBKIT1</a>	
3 Piece	1200-2400 GPH	<a href="#">ATL-FBKIT3</a>	

## SIZING PUMPS FOR OVERFLOWING FOUNTAINS

Provide 10 - 15 gph per inch of active edge (where water is actively overflowing) for bubbling rocks, overflowing vases and basins:

10 - 15 gph x diameter in inches x 3.14

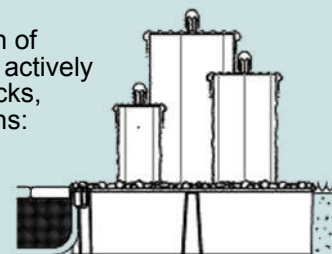

**For example:**

400 - 600 gph at 12" diameter,  
550 - 800 gph at 18", 750 - 1200 at 24"

## 3-WAY VALVE 3/4" MPT X 3/4" BARBED

- Suitable for the AquaBasin 30 & 45 Ultra 1100, 1500 and 2000 Installation Fittings
- 3 way valve allows you to control or shut-off the flow of each output with a simple knob.



Item #	List
<a href="#">AQS-88026</a>	

## FILTRIFIC PROFESSIONAL WATER FEATURE PRODUCTS

### GOOD IDEAS • BETTER PRODUCTS • THE BEST RESULTS.™

- Can be placed away from the water feature.
- Virgin LLDPE poly construction.
- Front & Back Discharge Ports for two pumps.
- Bolt down integrated lid system.
- Convenient filter access.
- Built in overflow & auto-fill ports.
- Additional Capacity Port for expandable water containment.

For equipment and sizing information, visit [filtrific.com](http://filtrific.com)

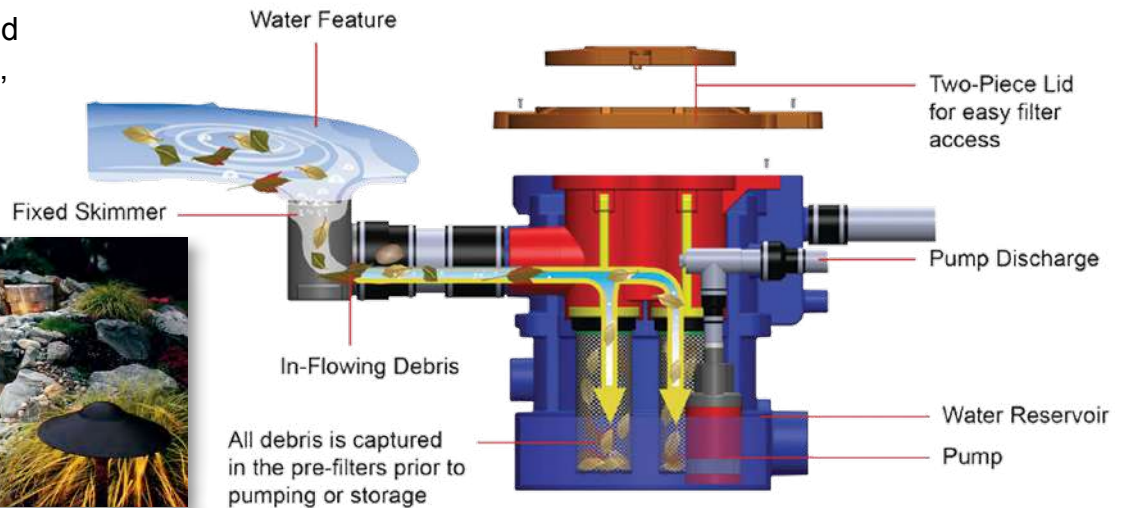

### T40F FILTER TANK

- Weight: 40 lbs.
- Dimensions: L: 29", W: 31.75", H: 24".
- A 4" intake port handles flow rates up to 80 GPM (4,800 GPH).
- 40 gallon Filter Tank (provides 20 gallons of water-in-motion reserve @ 9" residual water depth).



### T75F FILTER TANK

- Weight: 72 lbs.
- Dimensions: L: 35", W: 36", H: 32".
- A 6" intake port handles flow rates up to 200 GPM (12,000 GPH).
- 75 gallon Filter Tank (provides 40 gallons of water-in-motion reserve @ 9" residual water depth).

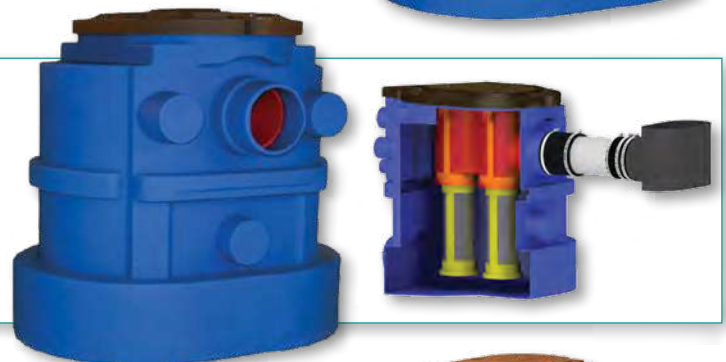

### T390F FILTER TANK

- Weight: 256 lbs.
- Dimensions: L: 70", W: 51.5", H: 48".
- 6" / 10" combination intake port handles flow rates up to 700 GPM (42,000 GPH).
- 390 gallon Filter Tank (provides 270 gallons of water-in-motion reserve @ 9" residual water depth).

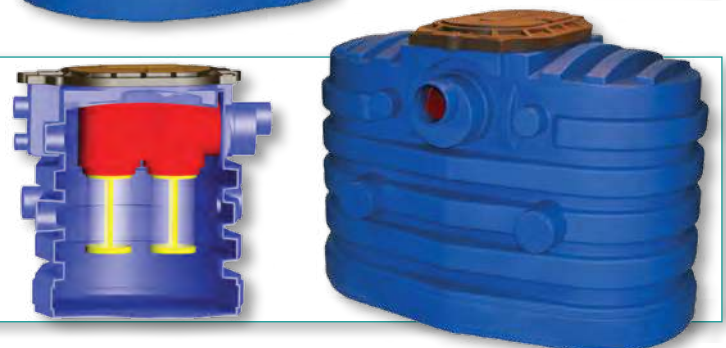

## FILTRIFIC PROFESSIONAL WATER FEATURE PRODUCTS

**GOOD IDEAS • BETTER PRODUCTS • THE BEST RESULTS.™**

Filtrific® Expansion Tanks connect with Filter Tanks to capture the water-in-motion when the pump is turned off.

### T40SP SIDE-POD

- Dimensions: L: 32", W: 25", H: 20".
- Side-nesting Expansion Tank connects to either side of the T40F or T75F Filter Tank.
- Adds an additional 40 gallons of water-in-motion reserve when connected to the T75F Filter Tank.
- Only requires a two foot deep hole.
- A 4" connection on both sides for connecting to a Filter Tank or additional Side-Pod Tanks.
- Includes vented cap.



### T165XP XTENDED-POD

- Dimensions: L: 63", W: 38", H: 32".
- Four 6" coupling ports for connection to Filter Tanks or additional Expansion Tanks.
- One 3" overflow port.
- Adds an additional 140 gallons of water-in-motion reserves when connected to the T390F Filter Tank.
- Adds an additional 95 gallons of water-in-motion reserve when connected to the T75F Filter Tank.
- Reinforced domed lid can be covered by the landscape.
- Lid vented for pressure equalization to allow easy fill and pump down of stored water.
- Includes coupling pipe & fittings.



## COMPONENT PACKS

When it comes to sizing the plumbing for your project, Filtrific makes it easy by providing Component Packages containing appropriate Filter Baskets, skimmer and PVC fittings and rubber couplings. All of these components are available separately for custom applications.

### VANISHING COMPONENT PACKS

Item #	<a href="#">FIL-CPX</a>	FIL-CP1	FIL-CP2	FIL-CP3A	<a href="#">FIL-CP3B</a>	<a href="#">FIL-CP4</a>
Use w/Tank	T40	T75	T75	T390	T390	T390
GPM	80	80	200	80	200	400
Intake Size	4"	4"	6"	4"	6"	10"
Fixed Skimmer	S44	S64	S66	S64	S66	S1066



### POND COMPONENT PACKS

Item #	FIL-CPY	FIL-CP5	FIL-CP6
Use w/Tank	T40	T75	T75
GPM	80	80	160
Intake Size	4"	4"	6"
Door Skimmer	S44D	S64D	S66D



**Call For  
System  
Pricing**





## STAINLESS STEEL WALL SKIMMERS

**S5** - For use with elevated pools, the S5 In-Wall Skimmer exits out of the bottom.

**S6** - In installations where the top of the Filter Tank is level with the pool edge, the S6 In-Wall Skimmer exits out the back for a same level connection with the Filter Tank.

- Rubber flap gasket adjusts with the water flow to minimize water noise.
- Strong narrow design for 10" or wider walls.
- Grounding connection provided.

GPM	Size	Disc.	Item #
60	13.5"L x 6.25"W x 5.75"H	3"	<a href="#">FIL-S5</a>
80	13.5"L x 10"W x 8"H	4"	<a href="#">FIL-S6</a>

## FIXED SKIMMER (VANISHING)

GPM	Use With	Item #
80	T40F	<a href="#">FIL-S44</a>
80	T75F & T390F	<a href="#">FIL-S64</a>
160	T75F & T390F	<a href="#">FIL-S66</a>



## SKIMMER HOOD

GPM	Use With	Item #
80	S44 & S64	<a href="#">FIL-SH1</a>
160	S66	<a href="#">FIL-SH2</a>

## SS SKIMMER GRATE

GPM	Use With	Item #
80	S44 & S64	<a href="#">FIL-SG1</a>
160	S66	<a href="#">FIL-SG2</a>



## DOOR SKIMMERS (POND)

Doors	GPM	Use With	Item #
1	80	T40F	<a href="#">FIL-S44D</a>
1	80	T75F & T390F	<a href="#">FIL-S64D</a>
2	160	T75F & T390F	<a href="#">FIL-S66D</a>



## 6" LID EXTENSION

The lid Extension securely connects to the top of the filter tank. Multiple Lid Extensions can be connected in order to match the surrounding grade. Two end bolts are included for use when stacking multiple extensions.

Fits	Item #
T40F	<a href="#">FIL-XT640</a>
T75F	<a href="#">FIL-XT675</a>
T390F	<a href="#">FIL-XT6390</a>

## FILTER BASKETS

Surgical grade stainless steel Filter Baskets separate debris from the water carried in through the skimmer. Interchangeable screen sizes provide customized filtering, to assure trouble free operation of pumps and related equipment.



Mesh	Micron	Use With	Item #
Super Fine*	100	T40F	<a href="#">FIL-E15040</a>
Medium	680	T40F	<a href="#">FIL-E2040</a>
Coarse	841	T40F	<a href="#">FIL-E1040</a>
Medium	680	T75F	<a href="#">FIL-E2075</a>
Coarse	841	T75F	<a href="#">FIL-E1075</a>
Medium	680	T390F	<a href="#">FIL-E20390</a>
Coarse	841	T390F	<a href="#">FIL-E10390</a>

\*Super Fine used in rain water harvesting.

## CIRCULATOR DISC

Designed to attach to the Filtrific door skimmer. The Circ Disc allows for water to be drawn off the bottom of the pond. Crucial for overall water quality.



GPM	Connection	Item #
20	1 1/2"	<a href="#">FIL-CD1</a>

## WALL MOUNT SKIMMERS & BOTTOM DRAIN



Designed specifically for concrete water features.

**S3L** - Wall mount skimmer is mounted on the inside of the fountain wall and returns down through the wall.

**S3S** - Wall mount skimmer is also mounted on the inside of the fountain wall but instead returns straight back.

**BDC-4** - Bottom drain provides a bottom draw point to a concrete water feature and can also be utilized as a drain when in-pool maintenance is to be performed. When used only as a fountain drain, the device can be connected to a drain pipe.

GPM	Min. Wall Required	Disc.	Item #
	8"	3"	<a href="#">FIL-S3L</a>
	3 1/2"	3"	<a href="#">FIL-S3S</a>
80	5"	4"	<a href="#">FIL-BDC4</a>

## SPOTLIGHTS

- Small remote drivers 18" from light decrease heat and pull through 1" sweeps.
- Submersible lights function equally well out of water and throughout the landscape.
- LED units inside lights are easily replaceable.
- Warm White matches 2800° Kelvin temperature of halogen and incandescent lighting.
- Spotlights feature 20' power cord and quick-connect plug for easy installation.
- Flat 2-wire cord on Warm White can be stripped and tied into existing systems.
- InfiColor Smart Module and App (not included) unlock the full potential of Color Changing lights.
- New Color Changing Lights connect to SOL Lighting with included plug adapter.



Input	Watts	Beam Angle	L x W	Item #	List
12 volt AC	2	45 degrees	2 1/8" x 1 1/8"	<a href="#">ATL-WWCS2</a>	
InfiColor	2	45 degrees	2 1/8" x 1 1/8"	<a href="#">ATL-CCCS2</a>	
12 volt AC	4	45 degrees	2 5/8" x 1 3/4"	<a href="#">ATL-WWCS4</a>	
InfiColor	4	45 degrees	2 5/8" x 1 3/4"	<a href="#">ATL-CCCS4</a>	

## FOUNTAIN LIGHTING

### LOW PROFILE RING LIGHT

- Epoxy-encased, cast brass light fits over 1 1/2" pipe and includes bushing for 1" applications.
- Warm White matches 2800° Kelvin color temperature of halogens and incandescents.
- Ring Lights feature 20' power cord and quick-connect plug for easy installation.
- Flat 2-wire cord on Warm White can be stripped and tied into existing systems.
- InfiColor Smart Module and App (not included) unlock the full potential of Color Changing lights.
- Color Changing Lights connect to SOL Lighting with included plug adapter.



Input	Watts	Beam Angle	Dimensions	Item #	List
12 volt AC	5	120 degrees	3 3/4" OD x 2" ID x 5/8" H	<a href="#">ATL-WWRL5</a>	
InfiColor	5	120 degrees	3 3/4" OD x 2" ID x 5/8" H	<a href="#">ATL-CCRL5</a>	

### FOUNTAIN LIGHT

- PVC body with bottom mounted cord fits into 1 1/2" socket fittings and 2" bore holes.
- Fountain Light accepts standard 3/4" rigid PVC or Kink-Free pipe.
- Warm White matches 2800° Kelvin color temperature of halogens and incandescents.
- Fountain Lights feature 20' power cord and quick-connect plug for easy installation.
- Flat 2-wire cord on Warm White can be stripped and tied into existing systems.
- InfiColor Smart Module and App (not included) unlock the full potential of Color Changing lights.
- Color Changing Lights connect to SOL Lighting with included plug adapter.



Input	Watts	Beam Angle	Dimensions	Item #	List
12 volt AC	2	120 degrees	2" W x 1 3/8" H	<a href="#">ATL-WWFL2</a>	
InfiColor	2	120 degrees	2" W x 1 3/8" H	<a href="#">ATL-CCFL2</a>	

## SPECIALTY LIGHTING

### SPOUT LIGHT

- Illuminates water flowing from Wall Spouts and bubbling boulders.
- Mounts inside Sch. 40 PVC FIPT fittings to light the stream of water from inside plumbing.
- Small diameter drivers are isolated 18" from light for optimal heat dissipation and fit through 1" conduit.
- LED units inside lights are easily replaceable.
- Warm White matches 2800° Kelvin temperature of halogen and incandescent lighting.
- Spout Lights feature 20' power cord and quick-connect plug for easy installation.
- Flat 2-wire cord on Warm White can be stripped and tied into existing systems.
- InfiColor Smart Module and App (not included) unlock the full potential of Color Changing lights.
- Color Changing Lights connect to SOL Lighting with included plug adapter.



Input	Watts	Beam Angle	L x W x H	Item #	List
12 volt AC	2	45 degrees	1 1/2" x 1 1/2" x 1 5/8"	<a href="#">ATL-WWSL2</a>	
InfiColor	2	45 degrees	1 1/2" x 1 1/2" x 1 5/8"	<a href="#">ATL-CCSL2</a>	

### LINEAR LIGHT

- Designed to wash walls, falls and spillways with a wide beam angle.
- Solid brass Bar Light includes dual bases or stainless steel L-brackets to mount to any hard surface.
- Mounted light rotates 30° in either direction for versatility in directing illumination.
- Warm White matches 2800° Kelvin temperature of halogen and incandescent lighting.
- Bar Lights feature 20' power cord and quick-connect plug for easy installation.
- Flat 2-wire cord on Warm White can be stripped and tied into existing systems.
- InfiColor Smart Module and App (not included) unlock the full potential of Color Changing lights.
- Color Changing Lights connect to SOL Lighting with included plug adapter.



Input	Watts	Beam Angle	L x W x H	Item #	List
12 volt AC	5	120 degrees	11 1/2" x 5/8" x 1 1/2"	<a href="#">ATL-WWBL5</a>	
InfiColor	5	120 degrees	11 1/2" x 5/8" x 1 1/2"	<a href="#">ATL-CCBL5</a>	

## POND LIGHTING

- Atlantic's Single and Triple Pond Light Kits come complete with everything needed to illuminate waterscapes and the surrounding landscape.
- Triple Light Kit includes 12' cord from transformer to junction plus 8' to each light.
- Warm White Pond Lights feature removable photocell light sensor with built-in memory.
- Light sensor turns lights on at dusk, off after 6 hours, even if photocell gets covered.
- Color Changing Pond Lights include new single-zone InfiColor Smart Module to unlock the full potential of Color Changing Lights.



Input	Watts	Beam Angle	L x W	Item #	List
12 volt AC	1	30 degrees	2 1/2" x 2"	<a href="#">ATL-SOLWPL1</a>	
InfiColor	1	30 degrees	2 1/2" x 2"	<a href="#">ATL-CCPL1</a>	
12 volt AC	3	30 degrees	(3) 2 1/2" x 2"	<a href="#">ATL-SOLWPL3</a>	
InfiColor	3	30 degrees	(3) 2 1/2" x 2"	<a href="#">ATL-CCPL3</a>	

## INFI-COLOR SMART MODULE & APP

The InfiColor Smart Module and mobile application at the heart of the Color Changing Lighting System allow users to program custom color sequences and transitions, set sequence timing and daily scheduling and unlock all RGB options on any Apple or Android mobile device. The InfiColor Smart Module now controls three individual zones via Bluetooth® mobile application and is compatible with all Atlantic Color Changing Lighting and Color Changing Colorfalls, past and present, with simple adapters included with every Module. The Atlantic Lighting System – the best has just gotten better.

- InfiColor Smart Module and App unlock the full potential of Color Changing Lights.
- Smart Module is wirelessly controlled via InfiColor App, no remote necessary.
- The 3 outlets can be synced and linked as a single zone or 3 zones may be controlled individually.
- Each outlet can control up to 40 watts of Color Changing Lighting for a total of 120 watts per module.

## BLUETOOTH INFI-COLOR APP

Makes custom colors, sequences, transitions, timing and daily scheduling of your Atlantic Color Changing Lighting or Color Changing Colorfalls accessible on any Apple or Android mobile device. Best of all, the InfiColor App eliminates the need for a separate remote control!

- Select any or all of the three zones to control.
- Choose any color visually or create a custom color with RGB sliders.
- Combine and save custom color sequences as favorites.
- Adjust brightness of sequences and solid colors.
- The three zones can be independently named and scheduled.



## LIGHTING WIRING: QUICK CONNECT WIRING

- Compact inline 4-outlet Block Splitters for Warm White and Color Changing simplify connections and mount on flat surfaces to neaten and organize wiring.

Input	Item #	List
12 volt AC	<a href="#">ATL-WWBSX4</a>	
InfiColor	<a href="#">ATL-CCBSX4</a>	



## EXTENSION CORD

Input	Length	Item #	List
12 volt AC	20'	<a href="#">ATL-WWEXT20</a>	
InfiColor	20'	<a href="#">ATL-CCEXT20</a>	

## CORD SEAL

- Fitting with expanding rubber core fits inside 1 1/2" socket fittings to create a leak-proof seal around 1/8" - 3/8" cords/
- Used to pass pump and lighting cords in underwater bulkhead or conduit connections through reservoir walls.

Hole Size	Item #	List
1 1/2" Sch 40 socket fitting	<a href="#">ATL-CSEAL15</a>	



## WIRING KITS & TRANSFORMERS: INFI-COLOR WIRING KIT

- Powers and connects up to three Color Changing Lights.
- Can be synced and linked as a single zone, or three zones may be controlled individually.
- Includes removable weatherproof caps for unused outlets.
- 30 watt solid state Transformer is fully weatherproof for worry-free outdoor installations.
- Add a larger Transformer and additional wiring components (not included) to power up to 120 watts of Color Changing Lighting, 40 watts per zone.

Input	Item #	List
120 volt AC	<a href="#">ATL-CCSM30X3</a>	

## WARM WHITE WIRING KIT

- Compact inline 4-outlet Block Splitter simplifies connections and mounts on flat surfaces to neaten and organize wiring.

Input	Item #	List
120 volt AC	<a href="#">ATL-WW30X4</a>	

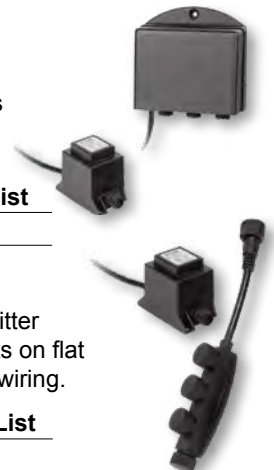

# WAC

## LANDSCAPE LIGHTING

### 12V SUBMERSIBLE TAPE LIGHTING

Flexible tape light with UV stabilized silicone seals that protect against water and dusts.

- Submersible up to 5 feet.
- Maximum of 40 ft per run to stay within 5 amps.
- Flexible linear lights maybe cut to desired length at the end of the run.
- Various lengths may be joined together with IP68 rated connectors.
- UV-stabilized silicone seals and protects the tape sections.
- Integrates with other landscape lighting products using the same transformer.



Length		Watts Per Ft	Item #	List
1'			<a href="#">WAC-801127BK</a>	
5'	2700K	2W	<a href="#">WAC-805127BK</a>	
10'			<a href="#">WAC-810127BK</a>	
1'			<a href="#">WAC-801130BK</a>	
5'	3000K	2W	<a href="#">WAC-805130BK</a>	
10'			<a href="#">WAC-810130BK</a>	



### 12V SUBMERSIBLE TAPE LIGHTING ACCESSORIES:

#### CLEAR CHANNEL

- Includes mounting hardware.



Length	Item #	List
5'	<a href="#">WAC-LEDTO24CH5</a>	

#### END CAP

Item # List



<a href="#">WAC-LEDTO24EC</a>	
-------------------------------	--

#### SURFACE MOUNTING CLIP

- Secures on both edges.



Quantity	Item #	List
10	<a href="#">WAC-LEDTO24C1</a>	

#### EDGE MOUNTING CLIP

- Secures on one edge.



Quantity	Item #	List
10	<a href="#">WAC-LEDTO24C2</a>	

#### INVISIBLE CLIP

- Spring clip secures beneath tape.



Quantity	Item #	List
10	<a href="#">WAC-LEDTO24C3</a>	

#### 3-WAY "Y" CONNECTOR

- Connects tape sections.



Item #	List
<a href="#">WAC-8002BK</a>	

#### 4-WAY "X" CONNECTOR

- Connects tape sections.



Item #	List
<a href="#">WAC-8003BK</a>	

#### JOINER CABLE (LONG)

- Connects tape sections.



Length	Item #	List
6'	<a href="#">WAC-800172BK</a>	
10'	<a href="#">WAC-8001120BK</a>	

#### JOINER CABLE (SHORT)

- Connects tape sections.



Length	Item #	List
6"	<a href="#">WAC-80016BK</a>	
12"	<a href="#">WAC-800112BK</a>	

#### LEAD WIRE WITH 5A FUSE

- 40' max tape run.
- Protects tape sections from over current.



Length	Item #	List
6'	<a href="#">WAC-800006BK</a>	
10'	<a href="#">WAC-800010BK</a>	



## LUNAQUA 3 LED

The LunAqua 3 LED pond light can be used above or below the water. Its compact size makes it an ideal niche light to hide in nooks and crannies or between rocks. The light also comes with a ground stake and an adjustable mounting base for fixed installation.



	Watts	Cord	Limited Warranty	Item #	List
Fixed beam 30 deg	3	25'	2 years	<a href="#">OAS-56463</a>	

## PROFILUX GARDEN LED RGB

Simple & economical; Design a colourful sea of LED light.

- Underwater LED spotlight with RGB illumination effects.
- Suitable for use in and out of the water to a water depth of 13 ft.
- Ideal for illuminating fountains, ponds, and garden landscapes.
- Fast and easy installation. Requires connection to an EGC network.



Light Flux	Beam Angle	Watts	Cord	Item #	List
213 lm	25 degrees	6	16.5 ft	OAS-72377	
Set of 3 - ProfilLux Garden LED RGB Kit				<a href="#">OAS-72376</a>	

## BRILLIANCE LED

### NICHE LIGHT

The perfect lamp to bring light to hard-to-reach places, whether under water, in a water feature, under stairs, stone walls, stone lanterns, or any small space. This omni-directional product solves the issue of fitting a fixture and a lamp into a small area. The Niche Light is ready to plug and play anywhere.

- 10 ft wire
- Water safe
- All in one lamp and fixture

Watts	Lumens	Temp	Lamp Life	Operating Range	Item #	List
3	215	2700K	30,000 hrs	12 VAC/DC	Call	



## WAC

LANDSCAPE LIGHTING

### SUBMERSIBLE LED LIGHT

Landscape 2" submersible recessed in-ground luminaire for up, down, side light applications. Comes with 30' long lead wire.

- Solid Stainless Steel
- Beam Angle: 25°
- Brightness: 170 lm
- 10 Year Warranty.
- Includes a detachable stainless steel mounting bracket for use in or out of water.

Watts	Item #	List
3000K	4.1 <a href="#">WAC-203130SS</a>	



## WATER TREATMENTS

### MULTI TEST STRIPS

Tests	Case	Item #	List
Alkalinity, pH, Nitrite, Nitrate, Hardness	25	24	<a href="#">PAQ-TS5</a>
6 Way test same as PAQ-5TS + Ammonia	25	24	PAQ-TS6
Copper Test Strip	50		<a href="#">ATL-TRIONTS</a>



### AQUA XTREME

A convenient liquid, single-phase, full-function water conditioner for use in koi and goldfish ponds. Use when: conditioning new water for ponds; adding water, fish or plants to ponds; and transporting koi and goldfish.

- Instantly ages pond water.
- Full functioned buffered water conditioner.
- Removes chlorine/chloramines & ammonia.
- Detoxifies heavy metals and Nitrite.
- Boosts alkalinity.
- Adds essential electrolytes.
- Adds a slime-coat replacer to reduce stress.

Treatment Volume	Size	Case	Item #	List
960 g	16 oz	12	<a href="#">ML-XTP16</a>	
1,920 g	32 oz	12	<a href="#">ML-XTP32</a>	
7,680 g	1 gal	4	<a href="#">ML-XTPG</a>	



### KH - ALKALINITY

#### Bio-Active Booster

Buffers your pond water to ensure nitrification and stable pH.

Size	Item #	List
2 lbs	<a href="#">ML-KH2</a>	
8 lbs	<a href="#">ML-KH8</a>	



## RAPICLEAR

RapiClear is designed to clear water gardens and koi ponds quickly and safely by combining suspended particulate together. Flocculation should last for several weeks after application.



Treatment				
Volume	Size	Case	Item #	List
8,000	16 oz	12	<a href="#">CRY-RAP16</a>	
16,000	32 oz	6	<a href="#">CRY-RAP32</a>	
64,000	1 gal	4	<a href="#">CRY-RAPG</a>	

## D-SOLV

Helps remove attached organic debris from waterfalls, streams and rocks. A weekly maintenance dosage eliminates complete pond shut down and annual clean-outs!

- Eliminates pond cleaning.
- Uses oxygen power.
- Deep cleans rocks, waterfalls, plant pots, streams & anywhere organic debris accumulates.
- Non-toxic to fish.



Treatment				
Square Ft.	Size	Case	Item #	List
800	2 lb	6	<a href="#">CRY-DSOLV</a>	
4,000	10 lb	2	<a href="#">CRY-DSOLV10</a>	
10,000	25 lb	1	<a href="#">CRY-DSOLV25</a>	

## ONEFIX

OneFix pond cleaner is a 12 Month Natural Clarifier designed to help keep water clean and clear year-round. The bacteria and enzyme strains found in OneFix are among the strongest offered on the market today.

- Can be used all year long.
- 100% safe for fish and plants.
- Removes organic debris quickly.



Treatment				
Volume	Size	Case	Item #	List
3,000	16 oz	12	<a href="#">CRY-ONEFIX16</a>	
12,000	32 oz	6	<a href="#">CRY-ONEFIX32</a>	
24,000	64 oz	4	<a href="#">CRY-ONEFIX64</a>	
48,000	128 oz	4	<a href="#">CRY-ONEFIX128</a>	

## SPARKLE FOUNTAIN CLEANER

A revolutionary product designed to keep your fountain clean & clear. Helps prevent stains, sludge, mineral deposits & organic contaminants from forming in basins.



Treatment				
Volume	Size	Case	Item #	List
80 g	8 oz	12	<a href="#">CRY-SPARKLE8</a>	

## PROFIX

Will help remove attached organic debris from waterfalls, streams and rocks.

- Contains a 9% solution for rapid action.
- Clears pond water regardless of color.
- Removes suspended organic debris.
- When using Profix, always make sure there is vigorous aeration using a waterfall, bubbler, fountain, air stone or spitter.



Treatment				
Volume	Size	Case	Item #	List
9,600	16 oz	12	<a href="#">CRY-PROFIX16</a>	
19,200	32 oz	12	<a href="#">CRY-PROFIX32</a>	
76,800	120 oz	4	<a href="#">CRY-PROFIX128</a>	

## MUCKOFF

MuckOff tablets are designed to sink to the bottom of the pond to quickly reduce muck and sludge caused from dead algae, leaves and fish waster.

- Eliminates muck & sludge.
- Breaks down dead algae, leaves & fish waste.
- Safe for all aquatic life.



Treatment				
Volume	Size	Case	Item #	List
4,000	24 Tab	12	<a href="#">CRY-MUCKOFF24</a>	
8,000	48 Tab	12	<a href="#">CRY-MUCKOFF48</a>	
16,000	96 Tab	6	<a href="#">CRY-MUCKOFF96</a>	

## VANISH LIQUID DECHLORINATOR

Removes chlorine, chloramine and heavy metals that are often present in city water supplies. Will also add a slime coat protectant to the pond water to help pond fish heal wounds and abrasions and protect them in times of stress.

- Immediately removes chlorine, chloramine and heavy metals.



Treatment				
Volume	Size	Case	Item #	List
3,200	16 oz	12	<a href="#">CRY-VAN16L</a>	
6,400	32 oz	12	<a href="#">CRY-VAN32L</a>	
25,600	1 gal	4	<a href="#">CRY-VANGL</a>	

## VANISH DRY DECHLORINATOR

Vanish will immediately remove chlorine that is present in city water supplies. Chlorine is toxic to fish, left untreated chlorine can cause gill damage and leave fish unable to breathe. Use Vanish when performing water changes or setting up a new pond.



Treatment				
Volume	Size	Case	Item #	List
24,000	8 oz	12	<a href="#">CRY-VAN8</a>	
192,000	2 lb	6	<a href="#">CRY-VAN2</a>	

## MICROBE-LIFT PL BACTERIA

The #1 pond product requested by name!

Specially formulated for water garden ponds. It is a 100% natural and safe beneficial bacteria that will not harm fish or plants.

- Reduces ammonia and nitrogen levels.
- Reduces noxious odors caused by algae, fish waste, leaves, etc.
- Improves dissolved oxygen levels.
- Dissolves away organic sludge and slime.
- Creates a healthy pond environment, promoting faster fish growth.
- Microbe-Lift Bacteria works in water temps below 12°C and will not lose effectiveness if frozen; bacteria will retain viability after thawing.



Size	Case	Item #	List
1 pt.	24	<a href="#">ML-10PLP</a>	
1 qt.	12	<a href="#">ML-10PLQ</a>	
1 gal.	4	<a href="#">ML-10PLG</a>	
5 gal.	1	<a href="#">ML-10PL5G</a>	

## SLUDGE AWAY

Formulated specifically for the removal of organic bottom solids that are slow to degrade.

- 80% faster than competitive products.
- Binds phosphate.
- Organic and microbial based.
- 100% active ingredients.
- Helps to improve pond clarity.
- Disperses quickly.
- 100% biodegradable.
- Provides "rapid and natural sludge and muck removal".
- Recommended for use with Microbe-Lift PL.



Size	Case	Item #	List
1 qt	12	<a href="#">ML-SAQ</a>	
1 gal	4	<a href="#">ML-SAG</a>	
5 gal	1	<a href="#">ML-SA5G</a>	

## PBL PROFESSIONAL BLEND BACTERIA

MICROBE-LIFT-PBL is a blend of microbes that contain specially formulated strains of bacteria manufactured for use by landscape, irrigation & pond professionals.

- Keeps your ponds clean & clear.
- Reduces ammonia and nitrogen levels.
- Remains effective over a wide range of pH conditions.
- Significantly reduces noxious odors caused by dead algae, fish waste.
- Improves dissolved oxygen levels.
- Reduces buildup of bird droppings, fish feed, and dead leaves.

1 gallon per 100,000 gallons is the usual initial dosage rate.

Size	Case	Item #	List	Size	Case	Item #	List
1 gal	4	<a href="#">ML-10PBLG</a>		55 gal	1	<a href="#">ML-10PBL55G</a>	
5 gal	1	<a href="#">ML-10PBL5G</a>		<i>Dosage rates vary from pond to pond.</i>			



## SPRING/SUMMER CLEANER

A Spring/Summer approach to the proper organic balance in ponds. Accelerates the breakdown of leaves, twigs, and other accumulated dead organic waste.

- Helps jump start a pond in the spring.
- Reduces buildup of dead leaves and residual organic sediment.
- Natural nontoxic and non-caustic.
- Each box contains: (8) 2 oz. water soluble packets of cellulose enzymes and hyper cellulose-producing bacteria.



Size	Case	Item #	List
1 lb.	12	<a href="#">ML-10SSC</a>	

## POND SHOCK

CrystalClear PondShock is a great alternative to chemicals to clear your pond water fast. The organic ball contains billions of all natural, live bacteria and enzymes that are designed to rapidly break down ammonia, nitrites and organic waste.



Treats up to	Item #	List
2,500 gph	CRY-PSB	

## POND BOSS PRO BACTERIA BLOCK

A blend of live bacteria and enzymes specifically designed to improve water quality and reduce unwanted odors. The sludge layer is most often responsible for undesirable odors and low oxygen levels.

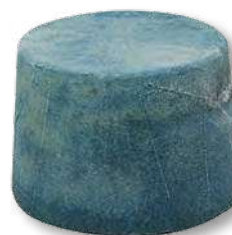

pond boss  
**The Block**  
5 lb. Bacteria Maintenance

- Treats up to 5 acre-feet of water over the course of 60 days.

Item #	List
<a href="#">PB-CBBPR5</a>	

## AUTUMN PREP BACTERIA

Specially formulated for late fall and winter use! Microbe-Lift A/P helps to accelerate the decomposition of leaves, scum, sediment, and other organic matter during the fall and winter months. Microbe-Lift A/P will also jump start your pond into a healthier environment in the spring.



- Helps maintain a healthy immune system in your fish during winter months.
- Reduces buildup of leaves and sediment all winter.
- Effective in dark conditions (under ice and snow).

Size	Case	Item #	List
1 qt	12	<a href="#">ML-AUTPREP</a>	
1 gal	4	<a href="#">ML-AUTPREPG</a>	

## BARLEY STRAW EXTRACT + LIQUID PEAT

An environmentally responsible, cost efficient pond conditioner that is a clean, easy, natural and organic approach to a healthy pond environment.



- Goes to work on contact.
- Organic peat softens pond water-reducing Nitrate and Phosphate levels.
- Contains natural buffering agent.
- **One bottle is equivalent to multiple barley straw bales.**

Size	Case	Item #	List
8 oz.	12	<a href="#">ML-CBSE250</a>	
16 oz.	6	<a href="#">ML-CBSE500</a>	
32 oz.	6	<a href="#">ML-CBSE1L</a>	
1 gal.	4	<a href="#">ML-CBSE1G</a>	

## BARLEY STRAW PELLETS

Highly effective in the control of algae. Barley straw pellets work faster, produce less mess, and are easier to apply than other barley products.



- Dissolves quickly.
- Buffers pH.
- Includes added peat and humates.
- Safe for use with all other bacteria products.
- Most effective when placed in shallow water (3') with sunlight and good circulation.

Size	Case	Item #	List
2.2 lb.	12	<a href="#">ML-10BSPP22</a>	
4.4 lb.	12	<a href="#">ML-10BSPP44</a>	
10.5 lb.	6	<a href="#">ML-10BSPP105</a>	
40 lb	1	<a href="#">ML-10BSPP40P</a>	

## POND BALANCE

Granular water treatment to bring a pond's ecosystem into a balanced state. Pond Balance is most often used to target unsightly "STRINGY" growth that can grow on streams, waterfalls & choke out many aquatic plants.



Treatment	Volume	Size	Case	Item #	List
	1,800	9.6 oz	6	<a href="#">INP-8750</a>	
	3,600	1.2 lbs	6	<a href="#">INP-8751</a>	
	10,800	3.6 lbs	6	<a href="#">INP-8752</a>	
	67,250	21.5 lbs	2	<a href="#">INP-8753</a>	

## POND COLOURANT

Safely colours pond water to a beautiful shade of blue while the enzymes assist the beneficial bacteria in your pond to create a healthy pond environment.

- Safe for humans, plants and aquatic life.
- Provides shade to inhibit algae growth.



## BIO BLUE

Treatment	Volume	Size	Case	Item #	List
	4,000 g	8 oz	12	<a href="#">ML-BB8</a>	
	8,000 g	16 oz	12	<a href="#">ML-BB16</a>	
	64,000 g	1 gal	4	<a href="#">ML-BBG</a>	

## BIO BLACK

Perfect for a mirror finish on reflecting pools!

8,000 g	16 oz	12	<a href="#">ML-BBLK16</a>
---------	-------	----	---------------------------

## ATLANTIC BLUE DYE PACKETS

- Atlantic Typhoon Pond Dye is the ideal colour for decorative ponds as it contrasts perfectly with lush green landscaping.
- Powerful Concentrated Powder.
- No-Mess Water Soluble Packets.
- Fish, Plant & Wildlife Friendly.



Treatment	Volume	Size	Item #	List
	1/2 Acre, 4-6' Deep	2 - 4oz. pkg	<a href="#">ATL-TPWDBLU2</a>	

## PH DECREASE & INCREASE

- Formulated in deionized water.
- Includes 2 pH decrease/increase for gentle effectiveness and 3 electrolytes to help maintain osmotic balance.
- Contains a slime coat ingredient for skin protection and stress reduction in pond fish.

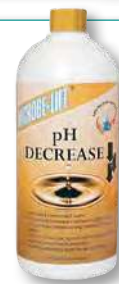

Size	pH	Case	Item #	List
16 oz	Down	12	<a href="#">ML-PHD16</a>	
32 oz	Down	12	<a href="#">ML-PHD32</a>	
16 oz	Up	12	<a href="#">ML-PHIN16</a>	
32 oz	Up	12	<a href="#">ML-PHIN32</a>	

# MICROBE-LIFT®



## HIGH GROWTH & ENERGY FOOD

In late spring when warmer temperatures arrive, koi and goldfish need a boost of protein for growth, since their reserves have been depleted over the winter. In the fall, a higher protein diet is also required as pond fish need to bulk up in preparation for their winter fast. Use at a minimum temperature of 68°F (20°C).

Size	Case	Item #	List
12 oz	12	<a href="#">ML-HGSM</a>	
2 lbs 4 oz	6	<a href="#">ML-HGMD</a>	
5 lbs 4 oz	6	<a href="#">ML-HGLG</a>	
Bulk Bag	40 lbs	1	<a href="#">ML-HGBAG</a>

## ALL SEASON VARIETY MIX FOOD

Legacy Variety Mix is the answer for how to feed a complete blend of fruits, greens, carbohydrates, protein, wheat germ, vitamins and probiotics to your koi and pond fish. It contains 25% of each our most popular Legacy foods: Fruits and Greens, Summer Staple, High Growth & Energy and Immunostimulant.

Size	Case	Item #	List
11 oz	12	<a href="#">ML-VMSM</a>	
2 lbs 4 oz	6	<a href="#">ML-VMMD</a>	
5 lbs	6	<a href="#">ML-VMLG</a>	
Bulk Bag	40 lbs	1	<a href="#">ML-VMBAG</a>

## FRUITS & GREENS FOOD

The first fish food manufacturer to commercially produce a food with such variety! We've done the cutting and blending for you, with apples, apricots, kiwis, mangos, papayas, peaches, pears, broccoli, cabbage, peas, red peppers, tomatoes, zucchini and spinach all in this scientific blend.

Size	Case	Item #	List
10 oz	12	<a href="#">ML-FGSM</a>	
2 lbs	6	<a href="#">ML-FGMD</a>	
4 lbs 8 oz	6	<a href="#">ML-FGLG</a>	
Bulk Bag	40 lbs	1	<a href="#">ML-FGBAG</a>

## FLOATING SUMMER STAPLE FOOD

As warmer weather sets in, begin increasing the frequency and quantity of your feedings. Legacy Summer Staple Food has animal protein and colour enhancers that are needed during this season.

Size	Case	Item #	List
10 oz	12	<a href="#">ML-SSSM</a>	
2 lbs	6	<a href="#">ML-SSMD</a>	
4 lbs 12 oz	6	<a href="#">ML-SSLG</a>	
Bulk Bag	40 lbs	1	<a href="#">ML-SSBAG</a>

## WHEAT GERM (COLD WEATHER) FOOD

Feed your pond fish Legacy Cold Weather Food (Wheat Germ) during the colder weather periods of spring and fall when night time temperatures can go below 55°F (13°C).

Size	Case	Item #	List
12 oz	12	<a href="#">ML-WGSM</a>	
2 lbs 4 oz	6	<a href="#">ML-WGMD</a>	
5 lbs 4 oz	6	<a href="#">ML-WGLG</a>	
Bulk Bag	40 lbs	1	<a href="#">ML-WGBAG</a>

## MINI PELLETS FOOD

Legacy Mini Pellets contain stabilized Vitamin C to help promote proper tissue development. Your little fish deserve the very best!

Size	Case	Item #	List
12 oz	12	<a href="#">ML-MPSM</a>	
2 lbs 4 oz	6	<a href="#">ML-MPMD</a>	
Bulk Bag	40 lb	1	<a href="#">ML-MPBAG</a>

## POND SALT CRYSTALS

Will help maintain a healthy pond environment and reduce the threat of parasitic disease in pond water. Naturally safe, nitrate & phosphate free.  
**1 Cup per 20 Gals.**



Size	Case	Item #	List
5 lbs	6	<a href="#">ML-PSALT5</a>	
18 kg / 40 lbs.		<a href="#">CH-SALT18</a>	

## MONTMORILLONITE CLAY

In the wild, carp use mud to get many of their micronutrients and minerals. Montmorillonite Clay will also "polish" your pond water.

- Provides fish nutrition through mineral ingestion.
- Improves fish colour.

Size	Case	Item #	List
2 lb	12	<a href="#">ML-CLAY2</a>	
4 lb	12	<a href="#">ML-CLAY4</a>	



## OASE PONDOVAC 5

Now even more powerful, the multi-function PondoVac 5 vacuums thoroughly and effortlessly removes debris and silt from ponds or pools, or from wet floors of any type. Thanks to the integrated wastewater pump the dirty wastewater can be optimally drained off without interruption to the suction, saving you the trouble of waiting for the vacuum to empty. Large wheels with whisper tires ensure stable movement through rough terrain as well as low-noise when in operation. The robust aluminum suction tubes, along with a transparent suction tube, permit precise and convenient vacuuming. Including an extensive nozzle package and suction hose/drain hose fittings.



- Pond and pool vacuum for uninterrupted, full power cleaning.
- The suction pump runs simultaneously, with the integrated waste pump, which empties the container continuously during use.
- On the outlet side, the PondoVac 5 has a plastic quick connect for a reliable and watertight seal, and easy removal for storage.
- Larger particles such as pebbles or leaves are retained in the pre-filter bag. The zippered bag makes for easy emptying.
- Larger wheels (6 in.) ensure stable movement through rough terrain as well as low-noise when in operation.
- Highly efficient suction depth of 7.5 ft. due to high performance 1800 W motor with optimized blade design.
- Suction capacity up to 2100 gal/h, depending on the implementation conditions.
- **Limited Warranty:** 2 years.

Max. Suction Depth	Suction Hose	Discharge Hose	Watts	Cord	Item #	List
7.5'	16'	32.8'	1800	25'	<a href="#">OAS-48080</a>	



Powerful Discharge Pump



Quick Disconnect



Large Commercial Wheels



Rock Bag



Fine Mesh Screen

## OASE PONDOVAC 4

**The best-selling, patented pond vacuum that doesn't take a break!**

Many pond maintenance needs can be addressed by removing sludge and debris build-up around the pond. The PondoVac 4's dual-chamber suction system provides continuous suction and makes the necessary, but bothersome task of cleaning the pond from sludge, fish waste, decaying vegetation and other floor sediment easy and quick.



- Includes: 4 suction tubes (aluminum and 1 clear), string algae nozzle, broadened adjustable floor nozzle, wet suction brush, area nozzle, brush nozzle, debris collection bag, 16' suction hose and 8' discharge hose.
- Built in handle and wheels for easy portability.
- **Limited Warranty:** 2 years.

Max. Suction Depth	Suction Hose	Discharge Hose	Watts	Cord	Item #	List
7.5'	16'	8'	1800	13'	<a href="#">OAS-50409</a>	

## OASE 2-IN-1 POND SCISSORS

- 2 in 1 pond scissors that simultaneously hold the cut plants when cutting.
- The head with adjustable work angle protects the pond liner from cuts and enables convenient work.

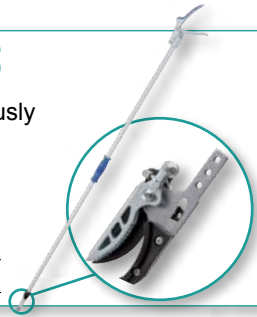

Handle	Item #	List
5'	<a href="#">OAS-46970</a>	

## OASE EASY PICK POND PLIERS

- Premium pond pliers for grabbing and removing cuttings or leaves in and around the pond.
- Length can be easily adjusted to 6.5'.
- For easy pond care - no need to get wet.
- Rubberized gripper for secure hold.
- Rubber covers for the grip arm are available as spare parts.



Telescopic Handle	Item #	List
6.5' Max.	<a href="#">OAS-42764</a>	

## OASE PONDNET

- Great for removing unwanted debris.
- Coated frame protects pond liner and fish.
- Telescopic handle extends up to 5.2'.



Handle	Item #	List
5'	<a href="#">OAS-46934</a>	

## HEAVY DUTY NET W/ EXTENDABLE HANDLE

A durable pond net designed for general maintenance and handling pond fish. The soft, coarse mesh prevents damage to fish fins and scales. The extendable handle makes it easy to skim those hard-to-reach areas in your pond.



Handle	Item #	List
36"-69"	<a href="#">AQS-98560</a>	

## ATLANTIC BIO BALLS

Extremely durable, lightweight Bio-Balls that are easy to clean and reduce channeling. Each ball has nearly 25 square inches of surface area for bacterial colonization.



Quantity	Size	Item #	List
150	1 1/2"	<a href="#">ATL-BB15</a>	

## MATALA FILTRATION MEDI

A high number of interstitial spaces in the tri-dimensional matrix of the filter media promotes early and even bacteria growth. Easy cleaning. Easy to cut.



	Density	Size	Item #	List
	Black	Low	48"x39"x1.5"	<a href="#">MAT-SBLK</a>
	Green	Medium	48"x39"x1.5"	<a href="#">MAT-SGRN</a>
	Blue	High	48"x39"x1.5"	<a href="#">MAT-SBLU</a>
	Grey	Super High	48"x39"x1.5"	<a href="#">MAT-SGRY</a>

## ANTI SPLASH MAT ROLLS

One issue with an architectural water feature is the splash that occurs from the falling water from a sheer descent water fall or spout. Anti-Splash Mat is designed to control splash resulting in a cleaner look without losing water.



Size	Item #	List
28" x 10'	<a href="#">ATL-CFSPMA2810</a>	
28" x 20'	<a href="#">ATL-CFSPMA2820</a>	

## ATLANTIC BIO-TECH FILTER MEDIA

Perfect for biofilters. This filtering media matt provides exceptional surface area for bacteria colonization.



Size	Item #	List
28" x 20' x 2"	<a href="#">ATL-MA2820</a>	

## POLY-FLO FILTER MEDIA

The industry standard in biological and mechanical filter matting.

- Certified fish safe.
- Durable, washable and UV resistant.



		Item #	List
Mechanical	White	1" x 28" x 24'	FM-SP24
Biological	Cream	1 1/4" x 28" x 20'	FM-JC24

## ATLANTIC BULK POND NETTING

- Pond Nets keep out leaves and other wind blown debris for a clean pond in the fall and spring.
- Netting your pond reduces organic wastes that can fuel algae growth and reduce oxygen levels.
- Durable poly netting is UV-resistant for extended lifespan.
- 1/2" x 1/2" openings keep out smaller windblown debris.
- Stakes available in 50 pc quantities for use with 100' rolled netting.

Size	Item #	List
10' x 100'	<a href="#">ATL-PN10100</a>	
20' x 100'	<a href="#">ATL-PN20100</a>	
30' x 100'	<a href="#">ATL-PN30100</a>	
50 Net Stakes	<a href="#">ATL-PNS50</a>	



## SMART POND THERMOMETER

Give yourself peace of mind by monitoring pond temperature throughout the year with the Aquascape Smart Pond Thermometer. This specially designed pond thermometer is easy to connect to your smartphone or tablet, allowing you to easily check the temperature of your pond or water feature using the Aquascape Smart Control App.

- Integrated display panel for monitoring without a smartphone or tablet.
- Connect to the app for automation triggers, historical data, trending reports, and educational notifications.
- Includes 12-volt transformer.
- Backed by a 3-year limited warranty

Item #	List
<a href="#">AQS-74013</a>	



## PONDGARD LINER ROLLS 45 MIL.

At the heart of thousands of decorative home water features are PondGard Rubber Liners. Combining flexibility and ease of installation with lasting durability, PondGard liners are the perfect choice for adding enjoyment and value to your backyard.

- Simple to install and repair - no special tools needed.
- Extreme conformability allows for endless design possibilities.
- UV, weather and algae resistant.
- Safe for fish and plant life.



	Item #	List	Item #	List
10' X 50'	<a href="#">FI-451050</a>		5' X 100'	<a href="#">FI-455100</a>
15' X 50'	<a href="#">FI-451550</a>		10' X 100'	<a href="#">FI-4510100</a>
20' X 50'	<a href="#">FI-452050</a>		15' X 100'	<a href="#">FI-4515100</a>
30' X 50'	<a href="#">FI-453050</a>		20' X 100'	<a href="#">FI-4520100</a>
40' X 50'	<a href="#">FI-454050</a>		30' X 100'	<a href="#">FI-4530100</a>
50' X 50'	<a href="#">FI-455050</a>		40' X 100'	<a href="#">FI-4540100</a>
			50' X 100'	<a href="#">FI-4550100</a>

## POND UNDERLAY

Underlay is a black polypropylene, nonwoven, needle-punched fabric. It may be used as a separator mat (under EPDM membrane), as a drainage filter fabric, or as a protection stone mat above the membrane.



	Item #	List
6 oz 7.5' x 100'	FI-UL75100	
6 oz 7.5' X 300'	FI-UL75300	



## QUICKSEAM ONE-SIDED TAPE

Ideal for covering & protecting EPDM seams, with adhesive on one side that can be easily used to hold EPDM seams together. It also works great for repairing tears, holes, and leaks of all varieties.



	Case	Item #	List
6" X 25'	8	<a href="#">FI-RBT025</a>	
6" X 100'	2	<a href="#">FI-RBT100</a>	

## LINER PATCH KIT

Quick, easy to use kit for repairing minor damage to your rubber pond liner.



### Included:

- Roller & scrubbing pad.
- Pair of disposable gloves.
- 2 - 6" x 6" QuickSeam patches.
- 2 ounce bottle of Quick Prime.
- Complete instructions on package.

Case	Item #	List
10	<a href="#">FI-RRK</a>	

## QUICKSEAM TWO-SIDED TAPE

For in between two pieces of liner. Can be used with cover tape for a double seal.



	Case	Item #	List
3" X 25'	16	<a href="#">FI-RST025</a>	
3" X 100'	6	<a href="#">FI-RST100</a>	

## QUICKPRIME PLUS

Dramatically improves bonding of liner to tape. A must when joining two pieces of liner.



	Case	Item #	List
Qt	12	<a href="#">FI-QPPQ</a>	
Gal	4	<a href="#">FI-QPPG</a>	

## SPRAY ADHESIVE/PRIMER

This specially designed, web spray contact adhesive has been formulated to both prime and adhere Firestone PondGard EPDM membranes to a vertical solid smooth substrate or wall in one step.



	Case	Item #	List
22.4 oz can	12	<a href="#">FI-SAP</a>	

## QUICKSEAM PATCH

A 6" diameter circular patch with adhesive backing for quick repair of small cuts and punctures.



	Case	Item #	List
	100	<a href="#">FI-PPI</a>	

## PIPE BOOTS

Firestone Pipe Flashings are designed to seal round penetrations through EPDM pond liners. For pipe penetrations from 1-6" in diameter. Includes stainless steel gear clamp.



	Size	Case	Item #	List
Small	1/2"-2 1/2"	10	<a href="#">FI-PBM</a>	
Large	1"-6"	10	<a href="#">FI-PBU</a>	

## LAP SEALANT

A rubber based sealant used to seam exposed membrane edges to provide additional waterproofing protection. 12 oz. tube seals 20 lineal feet and is applied using a standard caulking gun. Advanced formula has better waterproofing capabilities.

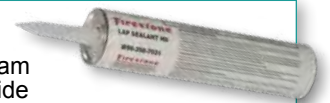

	Case	Item #	List
12 oz	28 / pail	<a href="#">FI-RLS</a>	



## BLACK SILICONE SEALANT

Ideal for sealing joints where liner attaches to filters, including the BioFalls snouts and skimmer faceplates. Aquascape silicone is fish safe, black in color, and easy to use.

Item #	List
10.1 oz	<a href="#">AQS-29186</a>



## PROFESSIONAL FOAM GUN CLEANER

Makes working with waterfall foam easier than ever. This cleaner will work to flush the foam gun clean of any foam or debris, allowing the gun to work like new again.

Item #	List
<a href="#">AQS-22011</a>	



## PROFESSIONAL BLACK WATERFALL FOAM

Easily fill joints and gaps between rocks and boulders, maximizing water flow in streams and waterfalls. Dries fast, lasts long, designed to create an air and moisture-tight seal for maximum foam yield and minimal waste.

Item #	List
<a href="#">AQS-30096</a>	



## RTV SILICONE SEALANT

Black RTV silicone sealant is used to create a watertight seal where liner is attached to filtration components.

Size	Item #	List
2.8 oz Tube	<a href="#">ATL-SN2800</a>	
10.3 oz Cartridge	<a href="#">ATL-BS10</a>	



## FLOATING THERMOMETER

- Injection molded inner body for increased accuracy.
- Ideal for knowing when to feed fish.

Item #	List
<a href="#">PM-T</a>	



## TERMINATION BAR

Use this aluminium Termination Bar any time that EPDM liner needs to be securely attached to concrete, wood, steel, etc. Bar is pre-punched for easy attachment. Trim off excess liner above termination bar then fill channel along top with Lap Sealant for a long lasting, waterproof seal.



Length	Case	Item #	List
10'	50	<a href="#">FI-TB10</a>	

## SEAM ROLLER

- 3" (76mm) Rubber Roller.

Item #	List
<a href="#">T-T37350</a>	



## BLACK ROCKIN FOAM

Industry Best!

An excellent foam product specifically designed for Water Gardening applications. Designed by professionals in the industry.

- Minimal Expanding Foam.
- Better density for secure rock placement and design.
- Better control during application.
- Patented dispersing trigger.
- Less waste - less to trim away.
- Reusable can which dispenses in all directions.
- Made from carbon for the black colour; not dye.
- Reduces ultraviolet deterioration of foam.
- Safe for Aquatic Plants and Animals.



Case	Item #	List
24oz can / 20oz Foam	12	<a href="#">FO-BSF</a>

## ATLANTIC BLACK WATERFALL GUN FOAM

An expandable foam sealant used to stabilize stones, fill voids and seal joints during waterfall construction. 29oz. cartridges and foam guns are indispensable tools for professionals.



Case	Item #	List
29oz can Gun Foam	12	<a href="#">ATL-LF1300</a>
Foam Gun		<a href="#">ATL-LF1315</a>

## POND SEALANT

- Natural stone colour.
- Moisture curing high performance polyurethane sealant with permanent elasticity.
- Suitable for non-chlorinated water immersion.
- Great for filling cracks and stopping leaks.



Case	Item #	List
30	<a href="#">SON-NP1</a>	

## ATLANTIC POND DE-ICER

- Pond de-icers maintain a hole in ice to allow the exchange of oxygen and other gases in wintery conditions.
- The Pond De-Icer allows oxygen to diffuse into pond water sealed off by ice, while toxic carbon dioxide and methane from decomposing organics diffuse out.
- Internal thermostat turns heater on just above freezing and off as water warms for fully automatic operation.
- Indicator light shines blue to show the De-icer is in standby mode when plugged in with water temperature above freezing.
- Indicator light shines green to show water temperature is below freezing and De-icer is in operation.



Watts	Cord	Item #	List
300	20'	<a href="#">ATL-PD300</a>	

## OASE FLOATING FOUNTAIN W/ LIGHTS

A beautiful water accent that aerates and decorates a large body of water. The fountain is an energy efficient product with 1/4 HP and quality constructed materials that provide maximum durability.

- For ponds up to 1/4 acre.
- Aerates and decorates large ponds.
- 3 fountainheads included (Trumpet, Single-Tier, & 3-Tier).
- 3 - 1 watt, LED lights with dusk-to-dawn sensor.
- 150' mooring line included.
- Minimum operating depth of 2.5'.
- **Limited Warranty:** 3 years.



LED Lights	Voltage	Watts	Cord	Item #	List
3 - 1 watt	120	130	50'	<a href="#">OAS-45383</a>	



## POND JET FLOATING FOUNTAIN

A floating fountain is ideal for those who want to add a special effect to an existing pond without much installation or for ponds that vary in water level.

The Pond Jet floating fountain is ready to connect and can be installed in minutes. Additional nozzle patterns can be installed.

- Spray 10'H x 10'W with included nozzle.
- Add a frothy nozzle for a different look - Page 9.
- **Limited Warranty:** 2 years.



Voltage	Watts	Cord	Item #	List
120	260	75'	<a href="#">OAS-54019</a>	

## POND JET LIGHT KIT

This light set for the Oase PondJet floating fountain consists of 3 Lunaqua 10 halogen lights (50W each), an underwater transformer and mounting brackets.

- **Limited Warranty:** 2 years.

Cord	Watts	Item #	List
150'	150	<a href="#">OAS-51071</a>	



## VFX AERATING FOUNTAINS

**Complete:** Comes with control panel, GFI, photo-eye for optional light kit, power cord, and mooring lines.

**Industrial strength:** Designed with heavy-duty stainless steel components for continuous operation, extended motor life and corrosion prevention (even in salt water).

**Energy efficient:** Low power consumption makes continuous operation affordable.

**Dependable:** Units are designed to operate continuously with minimal maintenance, even in shallow water.

They are the least likely fountains to clog of any manufacturer because of Kasco's deflector technology, prop guard, and standard bottom intake screen.

HP	Cord Voltage	Wty	Rec. Lights	Item #	List	HP	Cord Voltage	Wty	Rec. Lights	Item #	List		
1/2	50'	120	2 yrs	LR275	KAS-2400VFX	CALL	2	50'	240	3 yrs	LR375	KAS-8400VFX	CALL
3/4	50'	120	2 yrs	LR275	KAS-3400VFX	FOR	5	100'	240	3 yrs	LR375	KAS-51VFX	FOR
1	50'	120	2 yrs	LR275	KAS-4400VFX	PRICING							PRICING

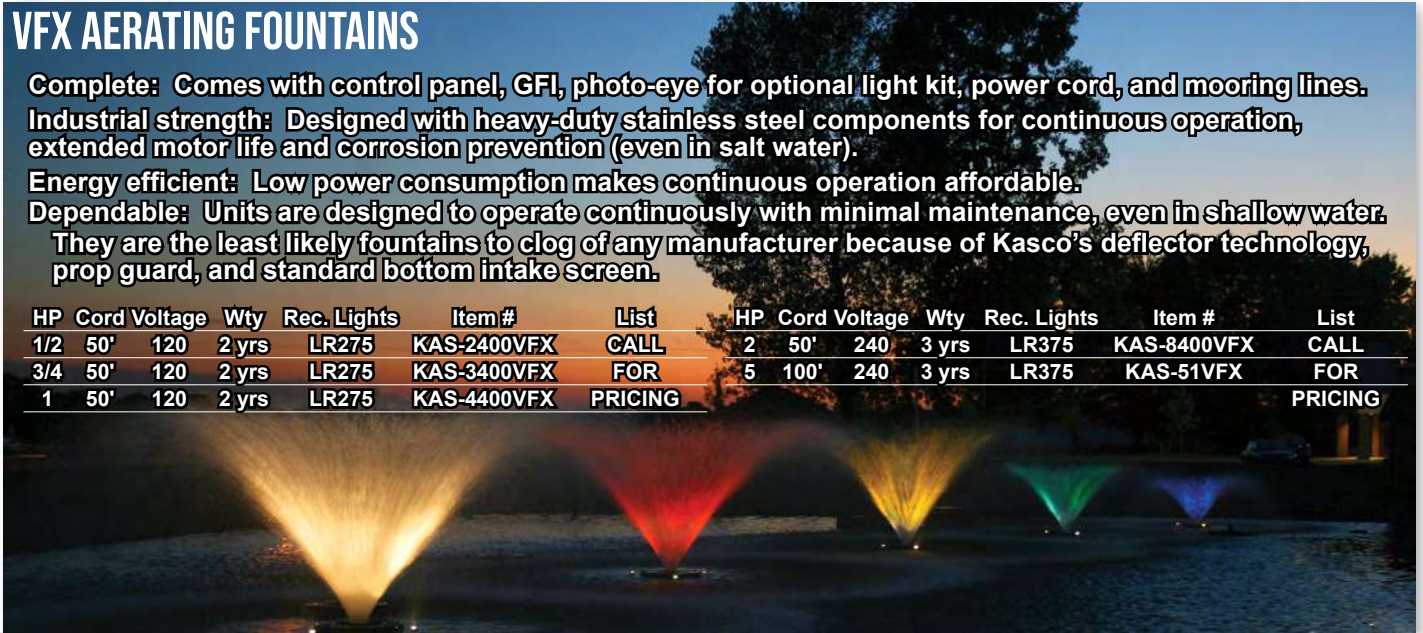

## WATER CIRCULATORS / DE-ICERS

The Kasco Circulator offers an economic and efficient way of moving stagnant water. This will greatly benefit your aquatic environment by limiting mosquito reproduction, introducing oxygen, eliminating thermal stratification and accelerating the breakdown of organic matter. These units perform across a wide range of depths from 2.5' up to 18'. Unit comes complete with motor & prop, horizontal float kit, 50' cable, 2-50' mooring lines.

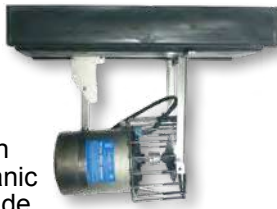

- Salt Water Compatible.
- Prevent winter kill and protect structures from ice damage - down to -30 degrees Fahrenheit.
- Great for moving and collecting noxious floating plants.
- Multiple motor mounts allow for five different angles, depending on water depth.
- 1/2, 3/4 & 1 HP models available.

## HIGH OXYGEN POND AERATORS

Add the most oxygen to your pond with an industrial strength Pond Aerator. Designed for the toughest jobs, high oxygen pond aerators are ideal for Aquaculture, Commercial, Waste Water, and or Agriculture applications.



- Provides high oxygen transfer rates (3 lbs of oxygen per horsepower per hour) at affordable costs.
- Operates in as little as 15" of water.
- Includes float and mooring ropes (control box and bottom screen optional).
- 1/2, 3/4, 1, 2, 3, & 5 HP models available.

## ROBUST-AIRE AERATION SYSTEMS

- No electricity in the water. There are no motors or electrical components in the water and no restrictions on swimming, boating, or fishing while the unit is operating.
- Easy to maintain. Most maintenance and inspection is performed from shore at the compressor enclosure.
- Energy efficient operation. Robust-Aire circulates the most water with the least energy expended. Our compressors are energy efficient and Robust-Aire diffusers produce a superior amount of water flow, exceeding other models by 10 to 40 percent.
- Remote installation. Electrical access near the pond may not be feasible or you simply may want to locate the system away from the pond setting. Air can be delivered to the system from 1/4 mile away.
- Manufactured by Kasco Marine. Known for manufacturing high-quality, energy-efficient water management equipment for over 40 years, Kasco Marine is a name you can trust.



### Each Kit Contains

- High Efficiency Piston Compressor.
- Sure-Sink Weighted Tubing.
- Air Diffuser Assembly(s).
- Fittings and Clamps.
- Available in 110 or 240 Volt.

\* Optional enclosures are available.

\* Works most efficiently at depths of 8' and deeper.



**See Page 11 for More Info**

**Call For Kasco Pricing**



## JF SERIES FLOATING FOUNTAINS MULTIPLE NOZZLES W/ EVERY FOUNTAIN!



MODEL	3400JF		4400JF		8400JF		3.1JF		5.1JF		7.3JF	
Horse Power	0.75 hp		1 hp		2 hp		3 hp		5 hp		7.5 hp	
Voltage	120V		120V		240V		240V		240V		208-240V 3ph	
Amperage	6.5 amp		11 amp		10 amp		13.4 amp		20 amp		20 amp	
Cord Length	50'		50'		50'		50'		100'		100'	
Warranty	2 yrs		2 yrs		3 yrs		3 yrs		3 yrs		3 yrs	
Min. water depth req.	17.5"		19"		20"		24"		26"		28"	
PATTERNS	H	W	H	W	H	W	H	W	H	W	H	W
A Linden	9'	29'	12'	31'	18'	30'	19'	35'	20'	35'	24'	28'
B Cypress	7'	17'	9'	28'								
C Willow	6.5'	21'	9'	31'	12.5'	28'	13'	35'	14'	36'		
D Juniper					8'	46'	9'	48'	10'	50'		
E Redwood					22'	7'	24'	8'	26'	8'		
F Spruce					19'	10'	21'	13'	24'	15'		
G Sequoia	13.5'	8'	18'	11'					21'	10'	26'	10'
H Birch	7'	5'	11.5'	8'	12'	11'	14.5'	10'	14'	12'	14.5'	13'
No Lights	KAS-3400JF		KAS-4400JF		KAS-8400JF		KAS-31JF		KAS-51JF		KAS-73JF	
List	<b>CALL FOR KASCO PRICING</b>											
Rec. Light Kit	LED3125		LED3125		LED3125		LED6125		LED6125		LED6125	



- 1750 RPM for lower power consumption and long life.
- Least likely to clog due to deflector technology, prop guard and bottom intake screen.
- Heavy duty stainless steel components.
- Comes with mooring lines and 50' of power cord (Longer cords available upon request).
- Control Panel w/built in GFI and photo cell for optional lights.

### PREMIUM NOZZLES (SOLD SEPARATELY)

Premium nozzles are only compatible with 2,3 and 5HP JF Series Fountains.



KAS-MAHOGANY



KAS-MAGNOLIA



KAS-MADRONE



KAS-PALM

## KASCO WATERGLOW RGB LED LIGHTING

Kasco Marine is pleased to offer Waterglow RGB LED Lighting, the ultimate decorative and/or event lighting for your J or VFX fountains. With the capacity to create 9 different colors, this remote control operated unit also allows the user to adjust brightness levels, has three sequencing patterns, and can be coupled with any music playing device that supports a 3.5mm Y connector (not included with unit.) This affords the user the ability to set the RGB light sequencing to the rhythm of the music!

- 9 total colors (white, warm white, red, green, blue, orange, yellow, cyan, magenta)
- Brightness Levels: each static color can be adjusted to 100%, 50%, 25%, 12% and 6%
- 3 Automatic Sequencing Modes: Flash (jump to next color), Bloom (transition from color to color), and smooth transition (smooth transition from color to color).
- Rhythmic Sequencing: Music input on the controller allows you to follow the rhythm of music played through your phone, tablet, laptop and more! Settings include fast change, medium and smooth transition.

Available in a 3 fixture (compatible with 1/2HP – 1HP) or 6 fixture (2HP – 3HP) kit, this color-changing RGB Lighting is built with the same durability you expect from Kasco.

- 2 Year Warranty.

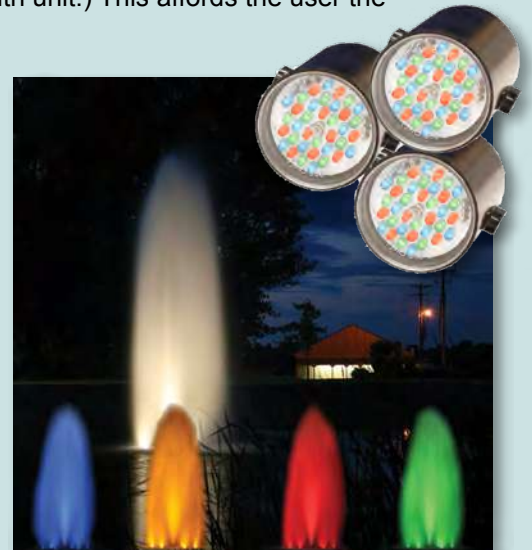

Kasco offers several sizes and models of low voltage lighting packages for use with all Aerating Fountain models. A low voltage lighting package added to any Aerating Fountain model will greatly enhance the aesthetics of your pond or lake and extend the enjoyment of your Kasco Aerating Fountain into the evening and nighttime hours.

# Kasco®

## LED LIGHT KITS

Kasco's LED lighting sets are ideal for any 1/2 to 7.5HP fountains.

These LED lights will work on any Kasco fountains above 1/4HP in size.

LED-3125 - This is a standard 3 fixture kit with bracketing to fit the floats. Ideal for 1HP and smaller fountains, the 3 fixture kit will illuminate the patterns on any of these models.

LED-6125 - This is a double set of the LED-3125 for a total of 6 lights including light brackets and the additional float brackets needed for installing on any 2HP to 7.5HP. The complete set includes everything you need to attach and use on these larger fountains and floats for a dramatic lighted display.



## STAINLESS STEEL LED LIGHT KITS

Kasco's stainless steel LED lights feature increased brightness and a more durable design. Rated at nearly 1,700 lumens per fixture, these warm white stainless steel lights are over three times brighter than Kasco's current composite option, providing excellent illumination for any 1/2HP-7.5HP Kasco Fountain or Aerator.

These lights are available in multiple power cord lengths up to 500 ft. At only 19 watts per fixture, the power consumption is a fraction of other lights on the market.

[Call For Kasco Pricing](#)

# OUR FULL LINE OF CATALOGUES ARE AVAILABLE ON VANISLEWATER.COM

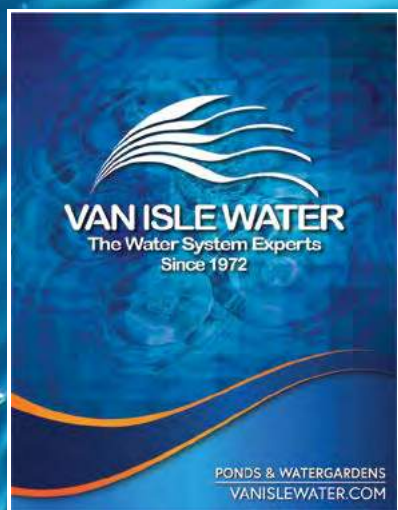

[Click to Download](#)

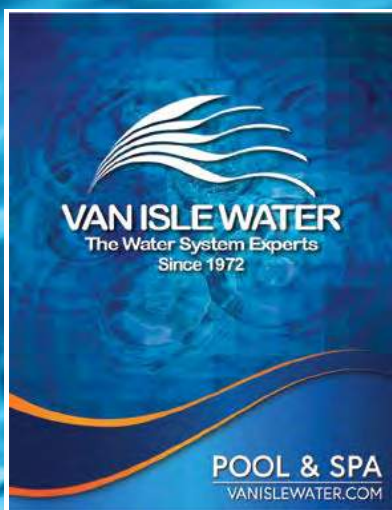

[Click to Download](#)



[Click to Download](#)

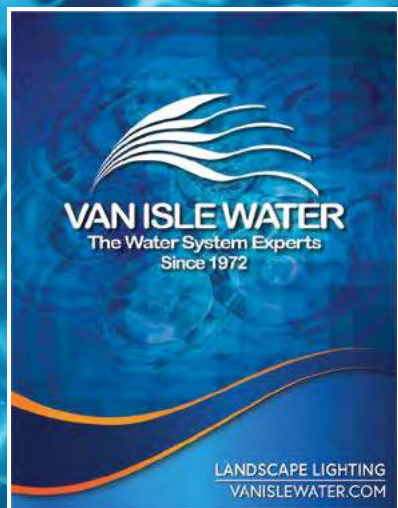

[Click to Download](#)

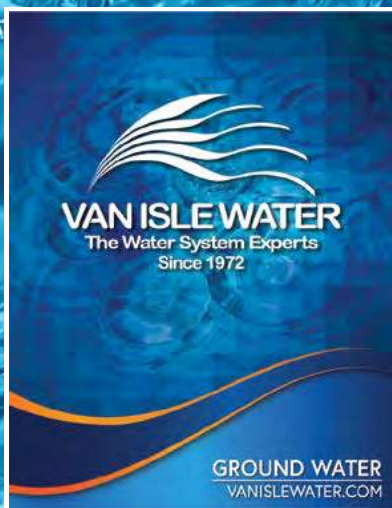

[Click to Download](#)



[Click to Download](#)

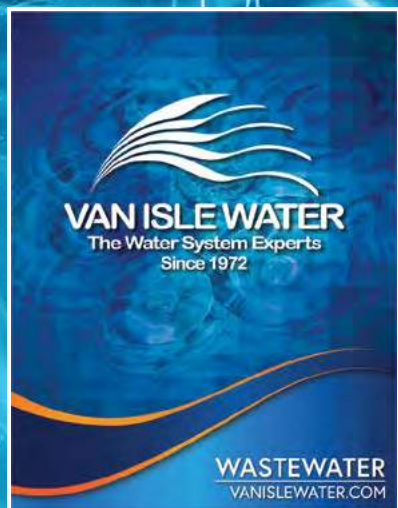

[Click to Download](#)

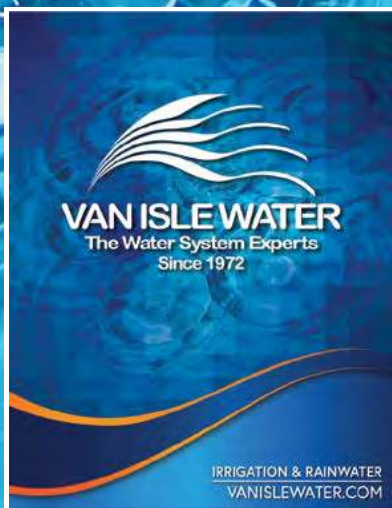

[Click to Download](#)



[Click to Download](#)



# VAN ISLE WATER

The Water System Experts  
Since 1972

**...but wait, there's more!**

## **Advantages of [vanislewater.com](http://vanislewater.com):**

- In-Depth Product Details and Specifications
- Download Your Receipts
- Print Your Invoices and Statements
- Look Up Full Transaction History
- Initiate Returns and Warranty Claims
- Pay Your Account Balance Online
- View All of Your Purchased Items
- Real Time Inventory Availability



461 Dupplin Rd, Victoria BC    1-888-444-8497 • 250-383-7145  
260B Tsolum Rd, Courtenay BC    1-800-665-8311 • 250-338-8737  
800-10281 Grace Rd, Surrey BC    1-888-444-8497 • 778-357-0257

**OPEN**  
*24 Hours*  
**ONLINE**