

EMPEROR AQUATICS, INC. [®]

SMARTUV

Sterilizers

OPERATING AND SERVICE INSTRUCTIONS

ITEM #02934-INS-SMART



OPERATING AND SERVICE INSTRUCTIONS

Congratulations on the purchase of your new SMART UV, we want you to be safe and successful with our equipment so please, read our instructions prior to installing and operating this equipment!

Section One: SAFETY RULES FOR ALL SMART UV MODELS - pg. 1- 2

Section Two: UV STERILIZATION FEATURES AND SPECIFICATIONS - pg. 2 - 5

Section Three: WHAT IS ULTRAVIOLET STERILIZATION - pg. 6

Section Four: PRE-INSTALLATION INSPECTION - pg. 6 - 8

Section Five: QUARTZ SLEEVE/UV LAMP INSPECTION - pg. 9 - 11

Section Six: THE QUARTZ SLEEVE ASSEMBLY - pg. 11 - 13

Section Seven: MOUNTING YOUR SMART UV - pg. 13 - 14

Section Eight: MANDATORY SMART UV WATER TESTING - pg. 14 - 15

Section Nine: ELECTRICAL REQUIREMENTS - pg. 15 - 16

Section Ten: UV LAMP INSTALLATION- pg. 16 - 17

Section Eleven: QUARTZ SLEEVE WIPERS - pg. 17 - 19

Section Twelve: SMART UV INSTALLATION/OPERATION - pg. 20 - 25

Section Thirteen: SMART UV WINTERIZING - pg. 26

Section Fourteen: SMART UV MAINTENANCE - pg. 26 - 27

Section Fifteen: SMART UV REPLACEMENT PARTS - pg. 28 - 31

Section Sixteen: TROUBLESHOOTING - pg. 32

Section Seventeen: CONTACT INFO - pg. 32

Warranty - pg. 33

Other Emperor Aquatics, Inc. Products - pg. 34 - 35

For pond calculating measurements and essential water quality parameters please visit us at: www.emperoraquatics.com

IMPORTANT!
Must Read!



Section One: **SAFETY RULES FOR ALL SMART UV MODELS**

IMPORTANT SAFETY INSTRUCTIONS PLEASE READ PRIOR TO
INSTALLATION AND OPERATION

**WARNING TO GUARD AGAINST INJURY, BASIC SAFETY PRECAUTIONS
SHOULD BE OBSERVED, INCLUDING THE FOLLOWING:**

**Water and electricity can be a dangerous combination.
Help us ensure your safety
PLEASE READ AND FOLLOW ALL SAFETY INSTRUCTIONS.**

DANGER: WARNING-Ultraviolet light is damaging to your eyes and skin!
Do not handle or stare at an operating UV lamp. Note that the UV light rays are invisible to the human eye and precautions should be taken to prevent UV energy from entering the eyes.

IMPORTANT: READ AND OBSERVE ALL IMPORTANT NOTICES AND LABELS ON THE UNIT.

IMPORTANT: For Your Safety - The quartz sleeve and or the UV lamp in this product may have been broken or damaged during transit! It is therefore **ESSENTIAL** that the unit be **CAREFULLY INSPECTED BEFORE CONNECTING TO ELECTRIC POWER** (See Section Five)

WARNING: Do NOT exceed 20 PSI (Pounds Per Square Inch)

DANGER: To avoid possible electric shock, special care should be taken since water is employed in the use of this aquarium and pond equipment. For each of the following situations, **do not attempt repairs yourself**. Call **EMPEROR AQUATICS, Inc. customer service department at 610-970-0440 Ext. 0** for services or discard the appliance.

DANGER: If the unit falls into the water, **DO NOT REACH FOR IT!** First unplug it and then retrieve it. If the internal electrical components of the unit get wet, unplug the unit immediately.

DANGER: If the unit shows any sign of water leakage, immediately unplug it from the power source.

IMPORTANT: Carefully examine the unit after installation. It should not be plugged in if there is water on any part not intended to be wet.

DANGER: Do not operate this unit if it has a damaged cord or plug, if it is malfunctioning, or if it has been dropped or damaged in any manner.

IMPORTANT: Close supervision is necessary when any appliance is used by or near children, and our equipment is no exception.

IMPORTANT: Always unplug the unit from an electrical outlet when not in use, before servicing, cleaning or removing parts. Never yank the cord to pull the plug from the outlet. Grasp the plug and pull to disconnect.

IMPORTANT: SMART UVs are designed for low-pressure water applications with or without aquatic livestock. **DO NOT use the EMPEROR AQUATICS, Inc. SMART UV for any application other than its intended use. The use of attachments not recommended or sold by Emperor Aquatics Inc. may cause unsafe conditions and possibly void any warranty.**

IMPORTANT: This unit must be wired in conjunction with a properly grounded, ground fault interrupter circuit (GFI). Only (3) three wire grounded cables suitable for outdoor use should be used to connect this unit. If joining cables for outdoor use, a suitable watertight cable connector must be used. If an extension cord is necessary, a cord with a proper rating should be used. A cord rated for less amperes or watts than the appliance's rating may overheat. Care should be taken to arrange the cord so that it will not be tripped over or pulled. (If in doubt consult a qualified electrician)

NOTE: Warping of the UV body may occur when left in direct sun light without water inside to help dissipate the heat.

WARNING: DO NOT operate the unit in “no-flow” situations.

Section Two: UV STERILIZATION FEATURES AND SPECIFICATIONS

Our GPH T-5 and T-6 low pressure mercury vapor germicidal lamps, convert approximately 40% of their electrical input watts into UV-C output watts within the germicidal action spectrum (meaning 40% of electricity used is converted into useful germicidal UV light), the highest UV-C output conversion among all UV lamps.

SMART UV FEATURES

- UL listed for indoor and outdoor use, fresh and salt water use.
- Long lasting GPH/T5 and GPH/T6 UV lamps (9,000 hours to 80% efficiency).
- Protective Quartz Sleeve (maximizes UV lamp output and safety)
- Watertight Design
- Easy-to-Remove Power Assembly
- Remote Power Supply
- UV Resistant High Density Plastic UV Housing
(**Lifetime warranty** against UV degradation)
- Utilizes the UV lamp to its maximum potential (maximum UV exposure)
- Non-UV Transmitting Clear Lamp Viewing Ports



**SMART UV
Specifications Charts
(See pages 3, 4, and 5)**

SMART UV Specifications Charts

SMART UV Lite Models



Model No. /Watts	Maximum Pond Size	Maximum Aquarium Size	No. Lamps /Watt	Water Flow Rate		Water Flow Rate		UV-C		Inlet /Outlet	Input Voltage
				Algae & Bacteria 30,000 µWs/cm ² Suggested/Maximum	GPH	Protozoa 180,000 µWs/cm ² Suggested/Maximum	GPH	Input Watts	Output Watts		
02218-B/18	1,100 Gal.	60 Gal.	1/18	219 GPH/356 GPH	37 GPH/60 GPH	18	5	21.75" x 2.5"	1/2" Barb	120VAC 50/60Hz	
02225-B/25	1,600 Gal.	90 Gal.	1/25	332 GPH/554 GPH	55 GPH/98 GPH	25	8	29.75" x 2.5"	3/4" Barb	120VAC 50/60Hz	
02240-B/40	2,900 Gal.	160 Gal.	1/40	589 GPH/983 GPH	98 GPH/164 GPH	40	14	44.75" x 2.5"	1" Barb	120VAC 50/60Hz	
02218-S/18	1,100 Gal.	60 Gal.	1/18	219 GPH/356 GPH	37 GPH/60 GPH	18	5	21.75" x 2.5"	2" Socket	120VAC 50/60Hz	
02225-S/25	1,600 Gal.	90 Gal.	1/25	332 GPH/554 GPH	55 GPH/98 GPH	25	8	29.75" x 2.5"	2" Socket	120VAC 50/60Hz	
02240-S/40	2,900 Gal.	160 Gal.	1/40	589 GPH/983 GPH	98 GPH/164 GPH	40	14	44.75" x 2.5"	2" Socket	120VAC 50/60Hz	
02280-S/80	5,900 Gal.	330 Gal.	2/40	1,178 GPH/1,967 GPH	196 GPH/328 GPH	80	28	44.75" x 14"	2" Socket	120VAC 50/60Hz	
02218/18	1,100 Gal.	60 Gal.	1/18	219 GPH/356 GPH	37 GPH/60 GPH	18	5	21.75" x 2.5"	1.5" Union	120VAC 50/60Hz	
02225/25	1,600 Gal.	90 Gal.	1/25	332 GPH/554 GPH	55 GPH/98 GPH	25	8	29.75" x 2.5"	1.5" Union	120VAC 50/60Hz	
02240/40	2,900 Gal.	160 Gal.	1/40	589 GPH/983 GPH	98 GPH/164 GPH	40	14	44.75" x 2.5"	1.5" Union	120VAC 50/60Hz	
02280/80	5,900 Gal.	330 Gal.	2/40	1,178 GPH/1,967 GPH	196 GPH/328 GPH	80	28	44.75" x 14"	1.5" Union	120VAC 50/60Hz	
02218-W/18	1,100 Gal.	60 Gal.	1/18	219 GPH/356 GPH	37 GPH/60 GPH	18	5	21.75" x 2.5"	1.5" Union	120VAC 50/60Hz	
02225-W/25	1,600 Gal.	90 Gal.	1/25	332 GPH/554 GPH	55 GPH/98 GPH	25	8	29.75" x 2.5"	1.5" Union	120VAC 50/60Hz	
02240-W/40	2,900 Gal.	160 Gal.	1/40	589 GPH/983 GPH	98 GPH/164 GPH	40	14	44.75" x 2.5"	1.5" Union	120VAC 50/60Hz	
02280-W/80	5,900 Gal.	330 Gal.	2/40	1,178 GPH/1,967 GPH	196 GPH/328 GPH	80	28	44.75" x 14"	1.5" Union	120VAC 50/60Hz	

WARNING: Do NOT exceed 20 PSI (Pounds Per Square Inch)

Note: PVC Adapter Kits not included (but available separately)

"Suggested" Water Flow Rates are based on UV Lamp End of Useful Lamp Life, 9,000 hrs. @ 80% output. **Maximum Water Flow Rates** are based on New Lamp Condition. All water flow rates incorporate a 90% UV transmittance factor, considering "Green Water" conditions.

SMART UV Sterilizer Models

SMART UV Sterilizer

Model No. /Watts	Maximum Pond Size	Maximum Aquarium Size	No. Lamps /Watt	Water Flow Rate		Water Flow Rate		UV-C		Inlet /Outlet	Input Voltage
				Algae & Bacteria 30,000 µWs/cm ² Suggested/Maximum	Protozoa 180,000 µWs/cm ² Suggested/Maximum	Input Watts	Output Watts	Dim. (Inches)			
02025/25	2,400 Gal.	130 Gal.	1/25	472 GPH/788 GPH	79 GPH/131 GPH	25	8	29" x 3.5"	1.5" Union	120VAC	50/60Hz
02040/40	4,700 Gal.	260 Gal.	1/40	943 GPH/1,574 GPH	157 GPH/262 GPH	40	14	43.75" x 3.5"	1.5" Union	120VAC	50/60Hz
02065/65	8,600 Gal.	480 Gal.	1/65	1,710 GPH/2,855 GPH	285 GPH/476 GPH	65	25	70.5" x 3.5"	1.5" Union	120VAC	50/60Hz
02080/80	9,400 Gal.	530 Gal.	2/40	1,885 GPH/3,148 GPH	314 GPH/525 GPH	80	28	44.5" x 15.5"	1.5" Union	120VAC	50/60Hz
02130/130	17,100 Gal.	960 Gal.	2/65	3,420 GPH/5,711 GPH	570 GPH/952 GPH	130	50	71.5" x 15.5"	1.5" Union	120VAC	50/60Hz
02025-W/25	2,400 Gal.	130 Gal.	1/25	472 GPH/788 GPH	79 GPH/131 GPH	25	8	29" x 3.5"	1.5" Union	120VAC	50/60Hz
02040-W/40	4,700 Gal.	260 Gal.	1/40	943 GPH/1,574 GPH	157 GPH/262 GPH	40	14	43.75" x 3.5"	1.5" Union	120VAC	50/60Hz
02065-W/65	8,600 Gal.	480 Gal.	1/65	1,710 GPH/2,855 GPH	285 GPH/476 GPH	65	25	70.5" x 3.5"	1.5" Union	120VAC	50/60Hz
02080-W/80	9,400 Gal.	530 Gal.	2/40	1,885 GPH/3,148 GPH	314 GPH/525 GPH	80	28	44.5" x 15.5"	1.5" Union	120VAC	50/60Hz
02130-W/130	17,100 Gal.	960 Gal.	2/65	3,420 GPH/5,711 GPH	570 GPH/952 GPH	130	50	71.5" x 15.5"	1.5" Union	120VAC	50/60Hz

WARNING: Do NOT exceed 20 PSI (Pounds Per Square Inch)

Note: PVC Adapter Kits not included (but available separately)

"Suggested" Water Flow Rates are based on UV Lamp End of Useful Lamp Life, 9,000 hrs. @ 80% output. **Maximum Water Flow Rates** are based on New Lamp Condition. All water flow rates incorporate a 90% UV transmittance factor, considering "Green Water" conditions.

SMART High-Output UV Sterilizer Models

High Output SMART HO UV Sterilizer

Model No. /Watts	Maximum Pond Size	Maximum Aquarium Size	No. Lamps /Watt	Water Flow Rate Algae & Bacteria		Water Flow Rate Protozoa		UV-C			
				30,000 μ Ws/cm ² Suggested/Maximum	1,980 GPH	3,600 GPH	180,000 μ Ws/cm ² Suggested/Maximum	260 GPH/330 GPH	Input Watts	Output Watts	Dim. (Inches)
025050/50	5,900 Gal.	330 Gal.	1/50	1,560 GPH/1,980 GPH	260 GPH/330 GPH	50	16	28" x 5.75"	2" Union	120VAC	50/60Hz
025080/80	10,800 Gal.	600 Gal.	1/80	2,700 GPH/3,600 GPH	450 GPH/600 GPH	80	26	43" x 5.75"	2" Union	120VAC	50/60Hz
025120/120	13,800 Gal.	770 Gal.	1/120	3,840 GPH/4,600 GPH	640 GPH/767 GPH	120	36	56" x 5.75"	2" Union	120VAC	50/60Hz
025150/150	19,100 Gal.	1,060 Gal.	1/150	5,040 GPH/6,360 GPH	840 GPH/1,060 GPH	150	47	70" x 5.75"	2" Union	120VAC	50/60Hz
025050-W/50	5,900 Gal.	330 Gal.	1/50	1,560 GPH/1,980 GPH	260 GPH/330 GPH	50	16	28" x 5.75"	2" Union	120VAC	50/60Hz
025080-W/80	10,800 Gal.	600 Gal.	1/80	2,700 GPH/3,600 GPH	450 GPH/600 GPH	80	26	43" x 5.75"	2" Union	120VAC	50/60Hz
025120-W/120	13,800 Gal.	770 Gal.	1/120	3,840 GPH/4,600 GPH	640 GPH/767 GPH	120	36	56" x 5.75"	2" Union	120VAC	50/60Hz
025150-W/150	19,100 Gal.	1,060 Gal.	1/150	5,040 GPH/6,360 GPH	840 GPH/1,060 GPH	150	47	70" x 5.75"	2" Union	120VAC	50/60Hz

WARNING: Do NOT exceed 20 PSI (Pounds Per Square Inch)

Note: PVC Adapter Kits not included (but available separately)

"Suggested" Water Flow Rates are based on UV Lamp End of Useful Lamp Life, 9,000 hrs. @ 80% output. **Maximum Water Flow Rates** are based on New Lamp Condition. All water flow rates incorporate a 90% UV transmittance factor, considering "Green Water" conditions.

Section Three: WHAT IS ULTRAVIOLET STERILIZATION

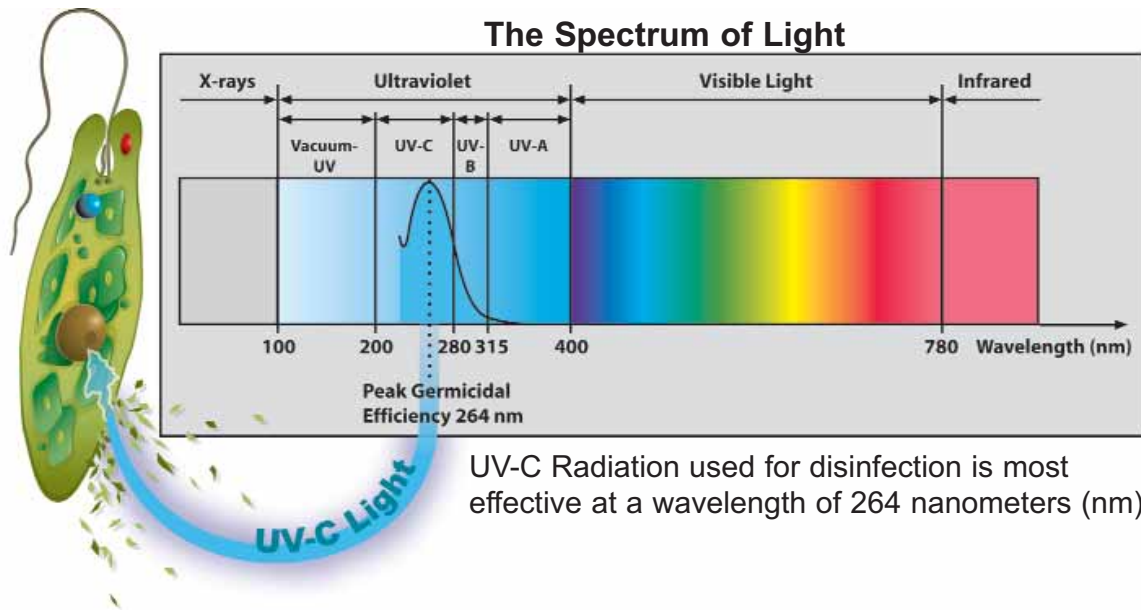

Using a low-pressure mercury vapor germicidal lamp. Input watts (voltage + current) are supplied to the UV lamp creating an electrical arc with the mercury inside. This reaction creates UV-C light. The UV-C light between 250nm and 280nm (the germicidal action spectrum) when directly exposed to living microorganisms such as bacteria and Protozoa is very effective at altering their DNA, disabling them from reproducing or even destroying them.

Microorganisms vary in type and size. Identifying the targeted microorganism, (Algae, Bacteria etc...) and matching its type and size to its established UV exposure rate, are prerequisites for eliminating that particular microorganism. Successful UV sterilization requires the UV-C (UV radiation @ 250-280nm) light to penetrate the microorganism's cell wall/cell membrane and destroy its nuclear material as discussed and shown in diagram above.

Successful UV sterilization in a water application requires the targeted waterborne microorganism to be in direct contact with the UV-C light (produced by the UV lamp) for a specific amount of time [UV exposure rate]. Established UV exposure rates must be applied to achieve successful UV sterilization.

Section Four: PRE-INSTALLATION INSPECTION

All SMART UV models are packaged complete, with all necessary components that are required to operate the unit. When unpacking your SMART UV, we recommend that a complete component inventory be taken to ensure that all components are included and accounted for, prior to installation.

The serial number of your UV unit is located on a small white label near the electrical end of the unit's housing. Smart HO UV units have their serial number labels located on the UV housing and on the power supply (ballast) label.

The model number of your UV unit can be found in two locations:

1. On the bar code label at the end of the box.
2. On the label placed in the middle of the UV Housing, with a hole punch indicating the model number.

Please review the following SMART UV component diagrams, matching the proper diagram to the individual SMART UV model contained in this package. Unpack your SMART UV and lay out the packaged components for inspection. Please review the information listed in this section to become familiar with the equipment's various parts.

SMART UV Component Diagrams

SMART UV Lite Models (#02218, #02225, #02240, #02280*)

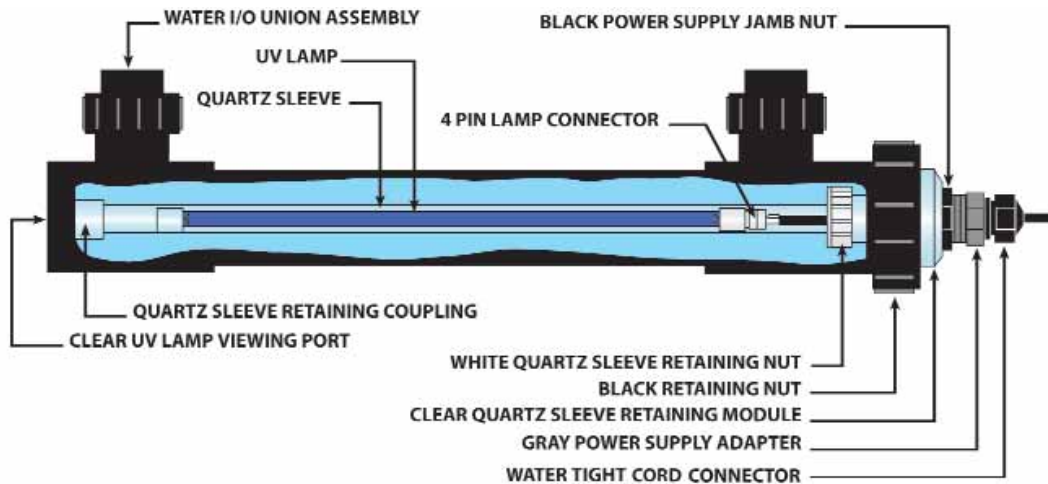

SMART UV Sterilizer Models (#02025, #02040, #02065, #02080*, #02130*)

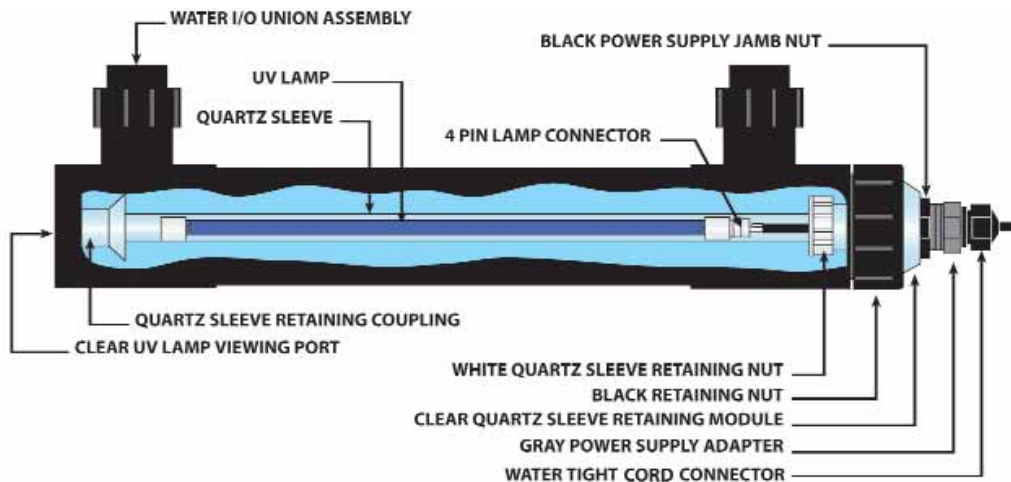

* Indicates Dual Body UVs. (see page 30 for more information).

SMART HO UV Sterilizer Models (#025050, #025080, #025120, #025150)

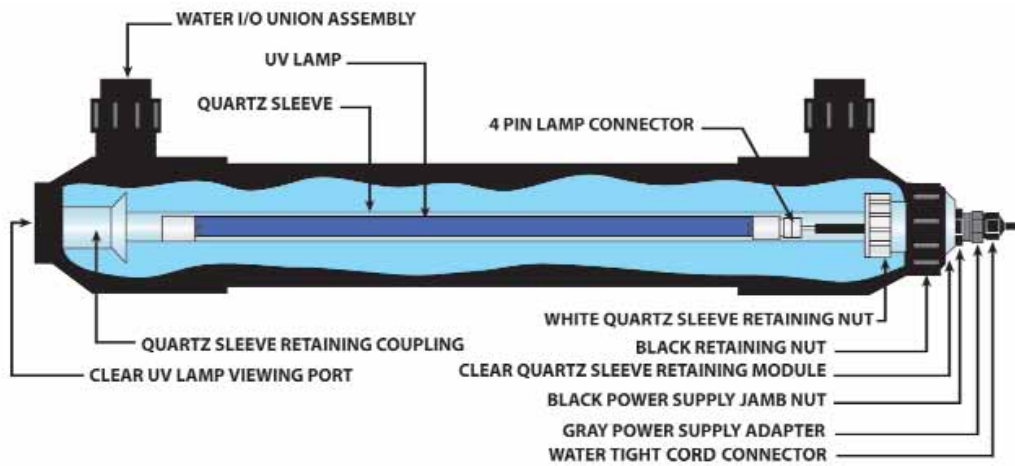

Included: UV Housing, Power Supply w/cord, Quartz Sleeve Assembly, Lamp, Packet Containing Instructions, and Inlet/Outlet fittings (fittings vary per unit)

SMARTUV[®] Power Supplies

Part Number

20100 - 18 - W, 25 - W, 40 - W, 65 - W
80 - W (x2), 130 - W (x2)



Fits SMART UV Lites and SMART UV Models 18 through 130 Watt

Part Numbers

202150-1 - 150 W



Fits SMART HO UV Model 150 Watt

Part Number

20105-MV - 37 - W, 50 - W, 80 - W, 120 - W



Fits SMART HO UV Models 37 through 120 Watt

- After Inventory is taken...make sure nothing is missing or damaged -

(1) The following SMART UV Models are packaged with their quartz sleeve assembly pre-assembled inside the UV housing, the lamp is packaged separately in a corrugated tube.

SMART Lite #02218, #02218-W, #02225, #02225-W, #02240, #02240-W, #02280, #02280-W

SMART UV #02025, #02025-W, #02040, #02040-W, #02080, #02080-W, SMART HO UV #025050, #025050-W, #025080, #025080-W

The Quartz Sleeve Assembly must be removed from the UV housing and inspected for damage prior to installation. Extreme care should be used while this procedure is being performed.

Quartz Sleeve/UV lamp Inspection Procedure

Step # 1- Carefully unpack the UV lamp(s) from their corrugated packing tubes and inspect for damage including broken glass, cracks, chips, fractures and pin holes. If damage has occurred please contact the place of original purchase immediately.



Step # 2 - Carefully, remove the quartz sleeve by unthreading the **A** Black Retaining Nut. Gently slide out the quartz sleeve assembly and inspect for damage including chips, cracks and pin holes. If damage has occurred please contact the place of original purchase immediately.



Step # 3 - After inspection, reassemble the quartz sleeve back into the UV housing. If installing the unit perform the Mandatory Water Test (**See page 14**).

Step # 4 - Inspect all other SMART UV components for damage, that includes the power supply/power cord, UV housing and unions.



(2) The following SMART UV Models are packaged with their UV lamp and quartz sleeve assembly separately wrapped and packaged in a corrugated triangle box.
SMART UV #02065, #02065-W, #02130, #02130-W,
SMART HO UV #025120, #025120-W, #025150, #025150-W

Both the UV lamp and quartz sleeve assembly must be removed and inspected for damage prior to installation. Extreme care should be used during this inspection.

Quartz Sleeve/UV Lamp Inspection Procedure

Step # 1 - Carefully unpack the clear quartz sleeve module/quartz sleeve and UV lamp from the triangle corrugated box and lay on a level, stable surface.



Step # 2 - The quartz sleeve assembly and UV lamp are packaged inside the triangle box separately. Unpack, remove the packaging material, and inspect for shipping damage.



Step # 3 - Inspect all other SMART UV components for damage, namely the power supply, UV housing and unions, prior to installation.



After receipt and inspection of the unit, if broken glass is found including cracks, chips, pin holes and hair line fractures of any kind) please contact the place of original purchase immediately for replacements. Do NOT call the manufacturer (Emperor Aquatics, Inc.) regarding this problem.

Section Six: THE QUARTZ SLEEVE ASSEMBLY

All SMART UVs utilize the same style quartz sleeve module assembly. (with the only exception being item #5 “clear quartz sleeve module”)

There are 7 components that make up a complete assembly and they include:

1. Quartz Sleeve
2. White Quartz Sleeve Retaining Nut
3. Rubber Gasket
4. Rubber O-ring
5. Clear Quartz Sleeve Module (#20622- UV Lite Models / #20603 UV Sterilizer & HO UV Sterilizer Models)
6. Clear Quartz Sleeve Module O-ring
7. Power Supply Gasket

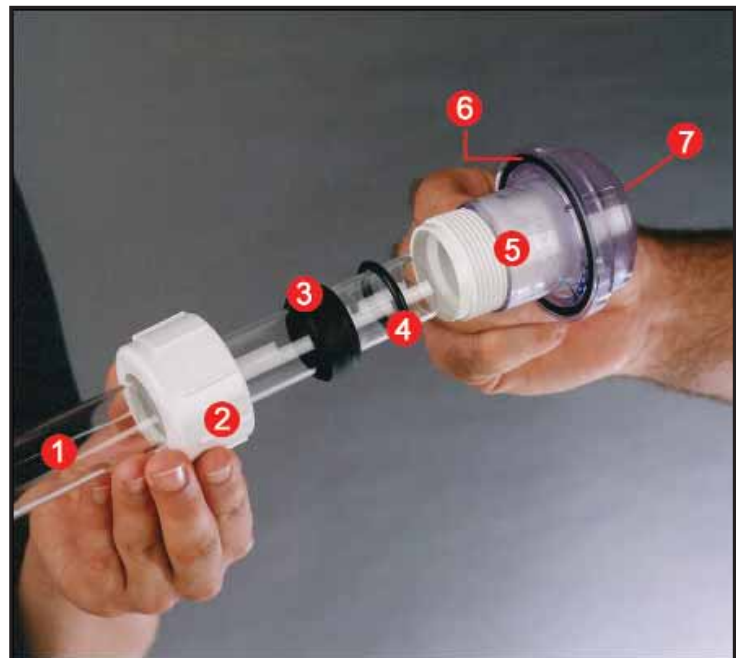

Improper Assembly May Result In Electrical Component Water Damage and Unsafe Conditions

Emperor Aquatics, Inc. is not responsible for improper re-assembly of these parts.

Assembly Instructions

6-1 First, position the white quartz sleeve retaining nut, rubber gasket and rubber o-ring over the open-end of the quartz sleeve as shown in Photo A.



6-2 Slide the "open-end" of the quartz sleeve (with nut/gasket & o-ring in position) into the clear quartz sleeve module (See Photo A).



6-3 Thread the white retaining nut onto the clear quartz sleeve module's male threads and hand-tighten (See Photo B).

6-4 While hand-tightening the white retaining nut onto the clear quartz sleeve module probe with your index finger inside the clear Q.S. module. Make sure that the open-end of the quartz sleeve mates smoothly with the inside lip of the clear Q.S. module; this signifies a good fit (See Photo C).



6-5 With the quartz sleeve is positioned inside the clear quartz sleeve module properly, finish hand-tightening the white retaining nut. With the white retaining nut "tight", the quartz sleeve should appear "straight" inside the clear quartz sleeve module (See Photo D), if it appears crooked, it may leak, in which case disassemble and try again.



6-6 Slide the quartz sleeve assembly into the UV housing carefully (See Photo E). The domed-end of the quartz sleeve should slide into the coupling located on the non-electrical end of the UV housing. (See Photo G on pg.13)



6-7 With the quartz sleeve assembly properly in place, the clear quartz sleeve retaining module should sit flush against the top of the UV housing (see photo F).



Note: Make sure that the "clear quartz sleeve module O-ring is in place", item #6.

6-8 Thread the black retaining nut (See Photo H) onto the male threads of the UV housing, hand-tighten only.

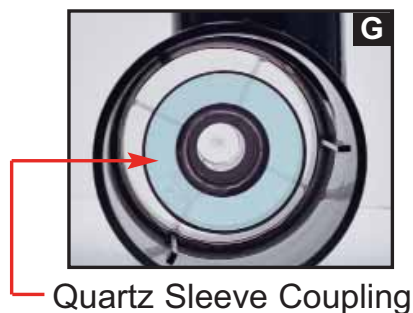

6-9. Please wait to install/connect the UV lamp and power supply until section Ten.

Section Seven: MOUNTING YOUR SMART UV

NOTE: The way UVs are mounted/positioned plays a very important role in the unit's performance and degree of safety. We **STRONGLY RECOMMEND** that you follow these instructions and guidelines precisely. **Any deviation** from these mounting instructions will void any warranty associated with the UV and all its components and may cause unsafe conditions.

Trapped air inside the UV housing during operation may create excessive heat, thus damaging the UV's internal components. (Follow instructions to avoid this.)

Vertical Mounting: Mount the SMART UV with the electrical end up. Use the bottom port as the inlet with the top port as the outlet.

Horizontal Mounting: Mount the SMART UV horizontally with the inlet/outlets facing up. If the unit is mounted horizontally but not level, the electrical end of the unit should be positioned higher than the non-electrical end. Choose the lower port for the inlet.

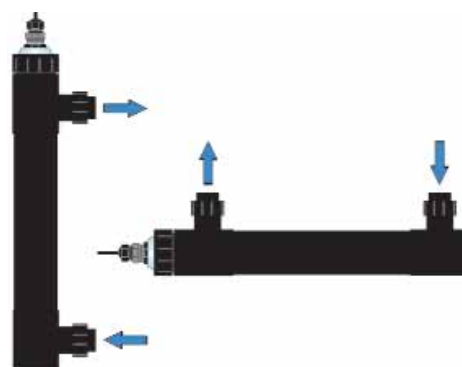

Power Supply Mounting: DO NOT SUBMERGE THE POWER SUPPLY IN WATER. The power supply may be camouflaged using rocks.

Note: Do not bury or place the power supply where heat or moisture can be retained.

Note: The UV Sterilizer may be covered in a thin layer of mulch but do not bury the unit.

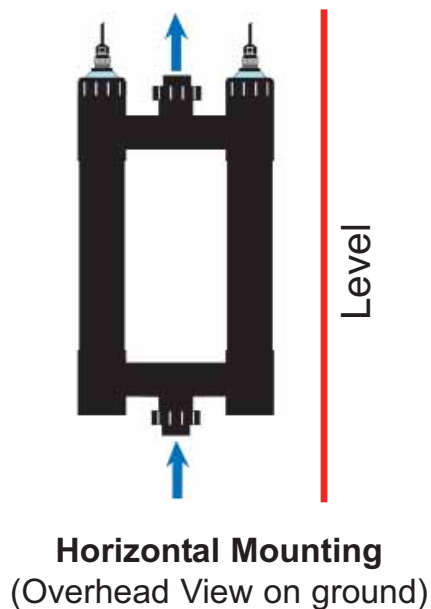

DO NOT mount/use the dual body UV (80 & 130 watt models) with one "tube" on top of the other or with one "tube" higher than the other. Keep unit as flat and level as possible.

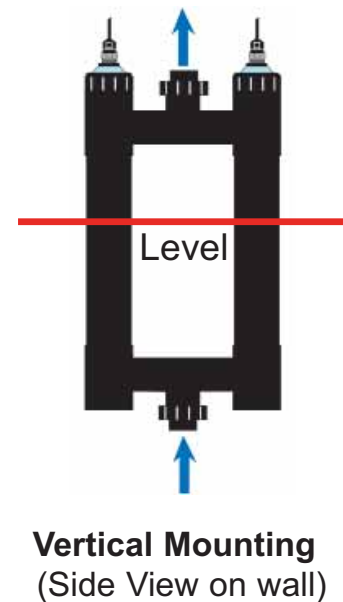

Section Eight: MANDATORY SMART UV WATER TESTING

Important Note: Failure to perform a water test could lead to conditions that will void your product's warranties.

A water test should be performed each time the quartz sleeve(s) is installed inside the unit's housing or when the quartz sleeve or gaskets and o-rings are replaced. [Once annually] Performing a water test is a precautionary measure that will determine whether or not the critical seal between the quartz sleeve and quartz sleeve module has been achieved.

Failure to achieve a proper quartz sleeve/quartz sleeve module seal during SMART UV operation will allow water to leak into the inside of the quartz sleeve, potentially damaging the UV lamp and other electrical components, which could develop into dangerous situations.

For instructions regarding the re-installation of the quartz sleeve assembly and UV lamp during replacement please review Section Six: (6)

Five Steps to Water Test All SMART UV Models

8-1. Prepare the SMART UV for permanent operation by plumbing it in-line, into a filter system using the plumbing hardware of your choice. If PVC glue is used, follow the glue manufacturer's instructions. Use a bypass assembly for greater water flow control. (as shown to the right)



8-2. With the unit plumbed for operation and the clear quartz sleeve module securely in place, remove the UV lamp from the quartz sleeve module.

8-3. Roll-up a few paper towels creating a core approximately $\frac{3}{4}$ " in diameter, 10" long then slide into the open quartz sleeve module port. Insert about six inches of the paper towel core down into the quartz sleeve, as shown at right.



8-4. With the paper towel in place, turn on the pump and recirculate water through the UV for at least thirty (30) minutes.

8-5. After thirty minutes of recirculating water through the UV, remove the paper towels from the quartz sleeve module. Inspect closely for moisture. If the paper towels are completely dry, your water test is complete and successful.

DO NOT OPERATE THE SMART UV UNTIL A PROPER QUARTZ SLEEVE MODULE/QUARTZ SLEEVE SEAL HAS BEEN ACHIEVED!

If moisture is detected on the paper towel the quartz sleeve's rubber gasket and o-ring have failed to achieve a seal and must be re-assembled; repeat the water test until a seal is achieved. (See Section Six for assembly instructions)

Section Nine: ELECTRICAL REQUIREMENTS

9-1. The electrical requirements for the UV sterilizer are marked on the unit's power supply label (120VAC 50/60Hz.). The unit must be plugged into a well-grounded electrical outlet. **Do not attempt to cut the ground post off of the 3-prong plug, doing so will VOID the unit's WARRANTY.**

9-2. This product must be grounded. If the unit should fail electrically, grounding provides a path of least resistance for electric current to pass to reduce the risk of electric shock. This product's cord is equipped with an equipment-grounding conductor and a grounding plug. The plug must be plugged into an appropriate outlet that is properly installed and grounded in accordance with all local codes and ordinances. If in doubt consult a qualified electrician.

9-3. DO NOT OPERATE THIS EQUIPMENT WITH TIMING DEVICES.

9-4. DANGER: Improper connection of the equipment-grounding conductor can result in a risk of electrocution. Check with a qualified electrician or service personnel if unsure that the outlet is properly grounded. Do not modify the product's plug. If it will not fit into the electrical outlet, have a proper outlet installed by a qualified electrician. Do not use any type of adapter with the product.

9-5. GROUND FAULT CIRCUIT INTERRUPTER PROTECTION: GFI's are designed to sense an imbalance in electrical current flow within the main electrical leads (leakage current). When this imbalance (maximum 5 ma per UL) occurs in the main leads, a comparator within the GFI outlet generates a trip signal which is applied to a coil that trips the main (normally closed) contacts. These contacts open and break the circuit.

Consider that all GFI's must trip at a leakage current of 5 ma. GFI "Spurious Trips" are caused by electrical devices that have small electrical leakage current to ground. Multiple outlets protected by one GFI allow for potential cumulative leakage currents caused by multiple appliances each leaking small amounts of current. For example: one pump plugged into an outlet that is part of a four outlet branch protected by one GFI will not trip the GFI with its 2 ma leakage current. However, two pumps and a UV with an cumulative leakage current of 7 ma's will trip the GFI. This is a common problem.

The solution to The GFI "Spurious Trip" problem is to operate the device on its own GFI protected outlet, or, remove other devices from the GFI protected branch of outlets. If the GFI is over ten years old you may want to consider replacing it.

Section Ten: UV LAMP INSTALLATION

Lamp Styles: Our UV lamps are manufactured with "color-coded" ceramic bases. White ends signify a Standard-Output UV Lamp while red caps signify a High-Output UV Lamp.



10-1. Power Cord Adjustment - There should be 4 inches of cord between the Gray Adaptor **3** and the 4-pin Lamp Connector **1**. The 4" cord distance **2** positions the lamp properly inside the quartz sleeve. The 3/8" Threaded Watertight Cord Connector **5** is adjustable: loosen it and gently move the cord through it. Care must be taken when retightening. If the Cord Connector's rubber gasket seal is dislodged during cord adjustment please make sure that it is properly reseated inside the male threaded portion of the connector.



10-2-A. After a successful water test and **without the power supply plugged into an electrical receptacle**, attach the lamp's 4-pins to the power cord's white 4-pin Connector **1**. Then slide the UV lamp back into the UV Sterilizer's quartz sleeve.

10-2-B. Whether the SMART UV housing is mounted horizontally or vertically, care should be taken when installing the UV lamp into the housing's quartz sleeve. Vertical installations require extra attention to eliminate the chance of the lamp dropping into the quartz sleeve and breaking it.



(next page)

10-3. With the UV lamp/power cord connection complete and the lamp now entirely inside the quartz sleeve, carefully screw down the Gray Power Supply Adaptor **3** into the Clear Quartz Sleeve Module **6**; hand tighten only. Next, screw down the Black Power Supply Jamb Nut **4** until it makes contact with the Clear Quartz Sleeve Module.

Remember, by loosening the 3/8" Threaded Watertight Cord Connector **5**, Power Cord **2** adjustments can be made. Make sure the 3/8" Threaded Watertight Cord Connector's gasket is properly in place before retightening.

IMPORTANT: If you do not have the black jamb nut back far enough before tightening the gray adapter, the gray adapter will not make contact with the power supply gasket and will enable outside moisture to enter the quartz sleeve assembly causing system failure.

Section Eleven: OPTIONAL QUARTZ SLEEVE WIPERS

RECOMMENDED FOR FRESH WATER APPLICATIONS ONLY

If you did not purchase a wiper model skip to section 12

11-1 Quartz Sleeve Wiper Assembly for SMART UV Lite Models 02218-W, 02225-W, 02240-W, 02280-W

All SMART UV Lite Wiper models have their quartz sleeve wiper seal located on the non-electrical end of the UV housing. A "Seal Nut" creates the seal between the UV housing and the quartz sleeve wiper rod. Inside the "Seal Nut" there is a rubber o-ring and two rubber seals, all are replaceable. (annually)

Replacing Rubber Seals

- A. Seal-Nut
- B. Replaceable Rubber O-Ring
- C. Replaceable Rubber Seals



To replace rubber seals, use a small screwdriver to pry the old seals out of the plastic nut. Replace with new seals (flat portion of the seals facing into the nut). Wet the seals before installation for assistance in creating a watertight seal.

Wiper Assembly Parts Breakdown

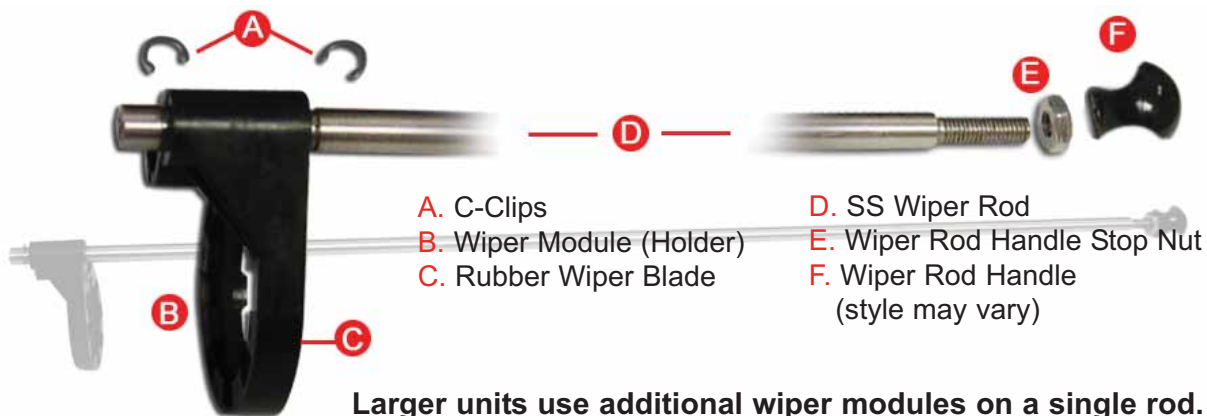

Quartz Sleeve Wiper Assembly

To install the quartz sleeve wiper:

1. Place the non-threaded side of the Wiper Rod through the hole of the Wiper Module and line up Wiper Module in between the two grooves.
2. Push the C-Clips onto the rod (one into each groove, opposite sides of the Wiper Module).
3. Push the threaded end of the rod through the assembled and installed "Seal Nut" from the inside of the UV Housing.
4. Thread on the Wiper Rod Stop Nut and Wiper Handle.
5. Push the Wiper Rod completely into the UV Housing.
6. Push the assembled Quartz Sleeve Assembly, domed end of the Quartz Sleeve, into the Wiper Module, gently continuing to push until the domed end of the Quartz Sleeve seats itself into the Quartz Sleeve Retaining Coupling.
7. Thread the Black Retaining Nut onto the UV Housing with the Clear Quartz Sleeve Module/Assembly in place, and tighten.
8. Installation is now complete.
9. Follow the water test instructions in Section Eight.

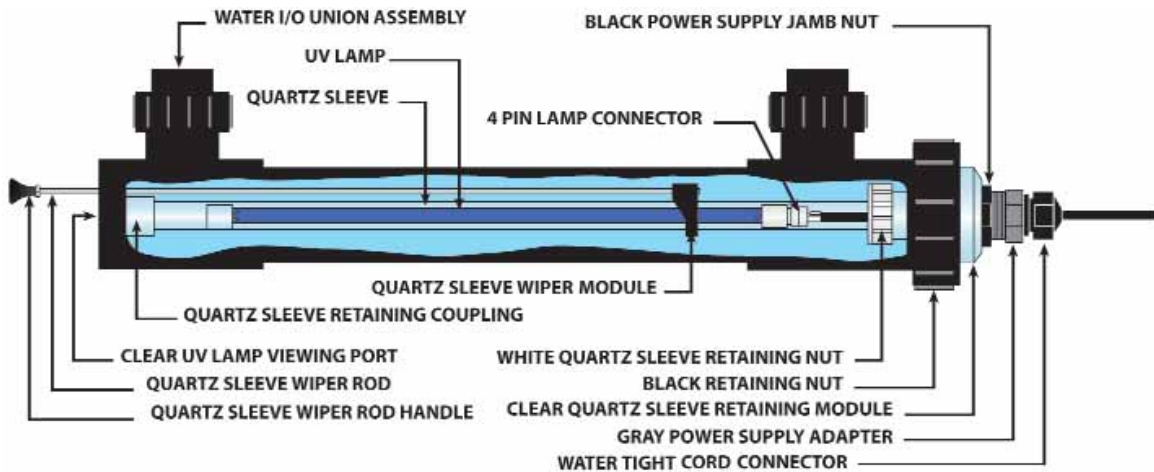
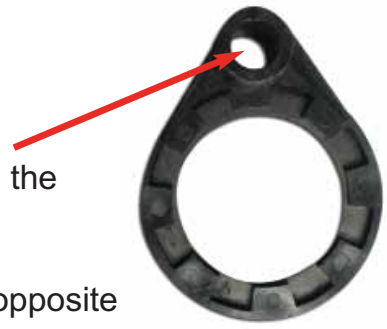

11-2 Quartz Sleeve Wiper Assembly for SMART UV & SMART HO Sterilizers 02025-W, 02040-W, 02065-W, 02080-W, 02130-W, 025050-W, 025080-W, 025120-W, 025150-W,

All SMART UV Sterilizer & SMART HO UV Sterilizer Wiper models have their quartz sleeve wiper seal located on the clear quartz sleeve module. Two rubber seals together create a seal between the clear quartz sleeve module and the quartz sleeve wiper rod; both are easily replaced.

To replace rubber seals, use a small screwdriver to pry the old seals out of the clear quartz sleeve module and replace with new seals (flat portion of the seals facing into the clear quartz sleeve module.) Wet the seals before installation.

- A. Clear Quartz Sleeve Module
- B. Replacement Rubber Seals



Wiper Assembly Parts Breakdown

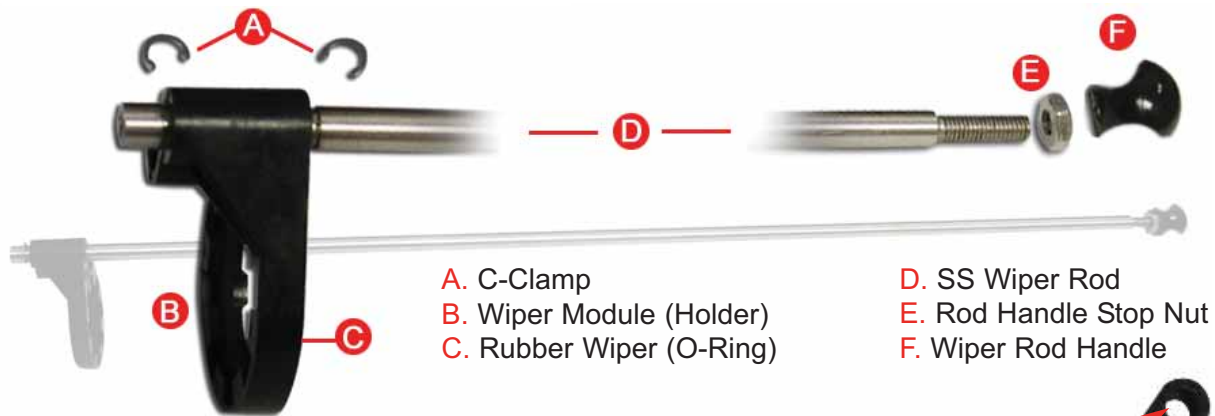

To install the Quartz Sleeve Wiper:

1. Place the non-threaded side of the Wiper Rod through the top hole of the Wiper Module and line up the Wiper Module in between the two grooves.
2. Push the C-Clips onto the Rod (one into each groove, opposite of Wiper Module)
3. Push the Domed End of the Quartz Sleeve through the Wiper Module that is attached to the Wiper Rod.
4. Slide the Wiper Module w/ Rod attached two thirds up the Quartz Sleeve.
5. Push the Wiper Rod threaded end completely into and through the Quartz Sleeve Module ¼" hole w/ Rubber Seals.
6. Thread on the Wiper Rod Stop Nut and Wiper Handle.
7. Push the Quartz Sleeve (open end) w/ White Retaining Nut, Quartz Sleeve Rubber Gasket and O-ring into the Clear Quartz Sleeve Module respectively, line-up properly and tighten down white nut (hand tight - See Section Six).
8. Gently slide the entire Quartz Sleeve/Wiper Assembly into the UV housing; make sure the domed end of the Quartz Sleeve slides into the Quartz Sleeve Coupling.
9. Thread the Black Retaining Nut onto the UV Housing with the Clear Quartz Sleeve Module/Assembly in place, hand tighten only.
10. Installation is now complete.
11. Follow water test instructions (See Section Eight).

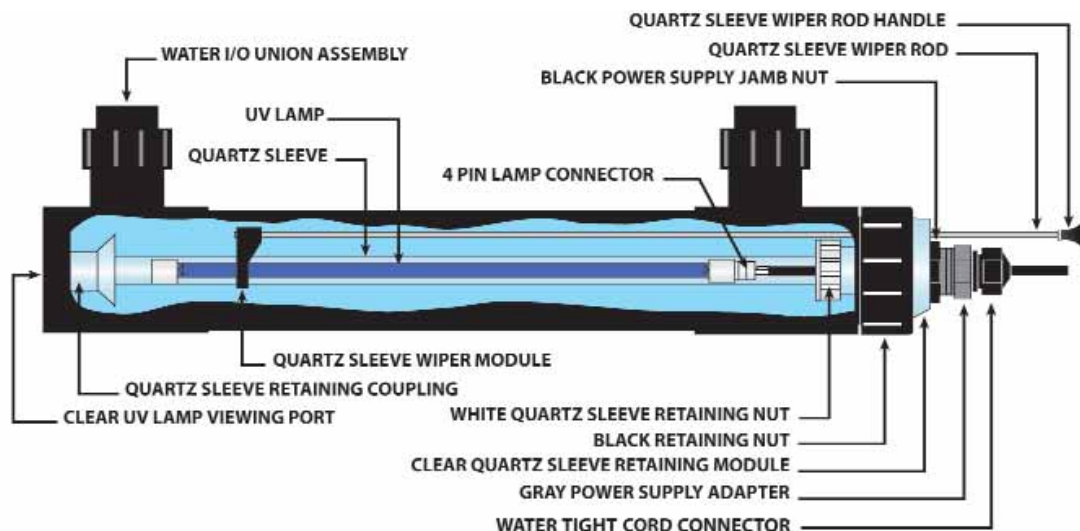

SMART UV Installation Locations

Our SMART UVs are used in a variety of applications to control waterborne pathogens; we encourage you to consider the installation/operation recommendations provided here.

Solid Waste Removal - By operating the SMART UV after the mechanical filter, its overall performance will be increased. Suspended solid waste will absorb UV light and reduce the UV transmittance through water.

Emperor Aquatics, Inc. Recommended Water Flow Rates - When operating our SMART UV sterilizers we encourage you to use our recommended water flow rates. Most competing UV's are supplied with exaggerated flow rate information that greatly jeopardizes their performance. Any deviation from our recommendations will void our "Green to Clear" in 3-5 days Guarantee.

12-1 Pond Installation Configurations

If product was purchased for an aquarium please skip to Section 12-2

12-1A Small Ponds (up to 1,000 Gallons) using a Dedicated Submersible Pump

For small ponds, or for applications where the SMART UV is operated independently from other filters, this installation configuration is ideal. Matching the pump to the SMART UV's recommended flow rate is critical to the UV's performance. Installing an adequate mechanical pre-filter on the pump suction ensures that solids-free water will be sent to the SMART UV. (See Diagram #1)

Diagram #1

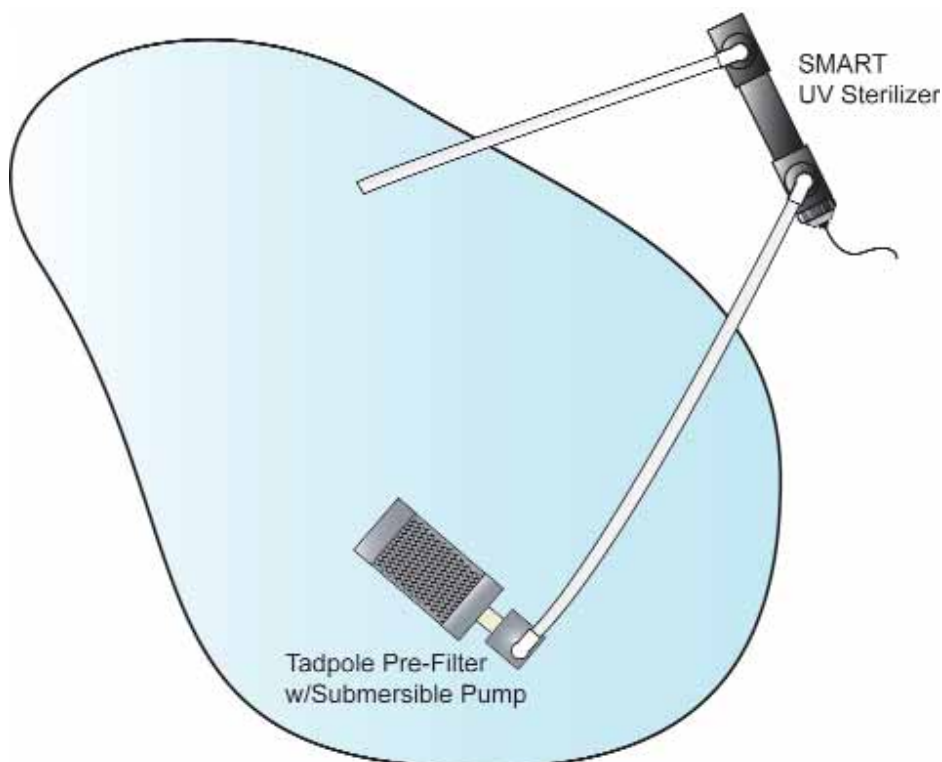

12-1B Small to Moderately Sized Ponds (up to 5,000 Gallons) using Skimmer and Falls

This is a very popular filter system style. Placing the UV between the skimmer box and the bio-falls filter ensures that pre-filtered water reaches the UV, increasing its performance while reducing maintenance. Often the capacity of the pump exceeds the capacity of the UV, if this is the case, install a by-pass manifold. Be sure that the skimmer is equipped with mechanical (solid waste removal) filtering capacity. (See Diagram #2)

Diagram #2

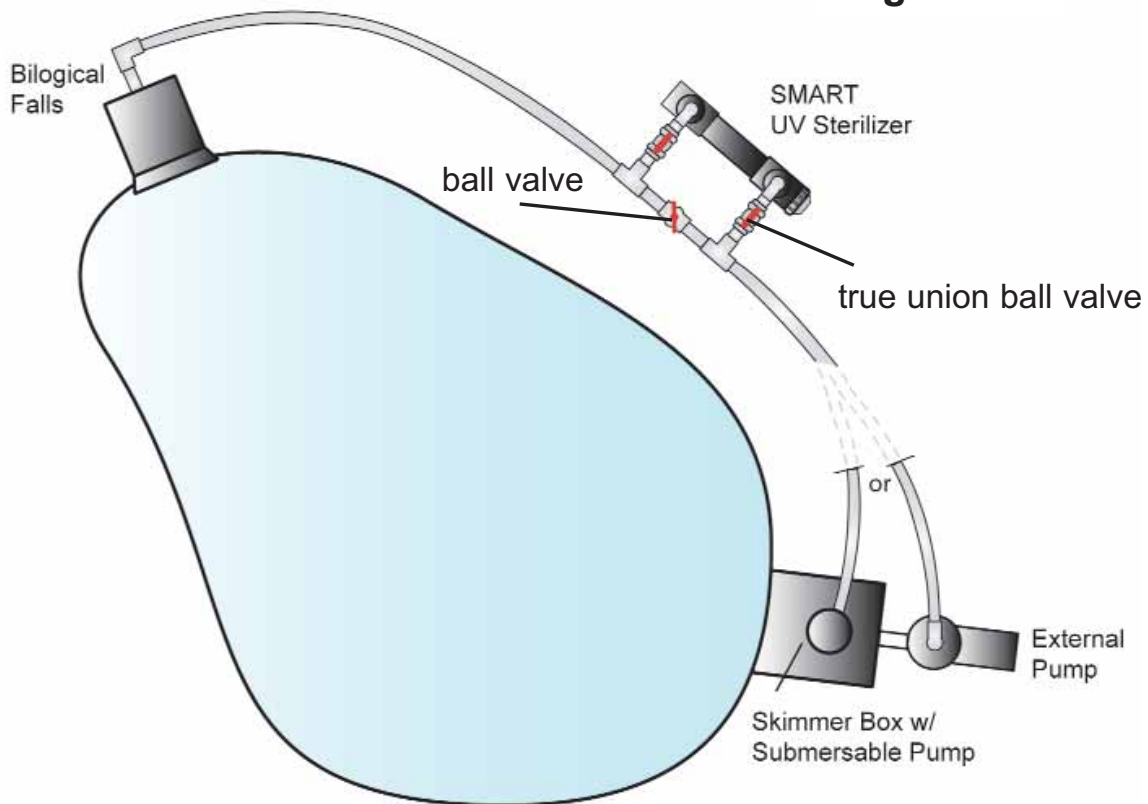

Note: Before gluing pipe or a reducer bushing into the UV's union or socket, remove the quartz sleeve assembly to prevent glue from dripping onto the quartz sleeve. Use Teflon tape on all threaded connections.

12-1C Larger Sized Ponds (above 5,000 Gallons)

Surface Skimmer/Pressurized Filter

This is one of the most efficient pond/exhibit filter system styles we can recommend. This system is simple yet it achieves critical filtering goals, such as good water circulation for increased solid waste suspension. The bottom drain/surface skimming capabilities ensure maximum waste removal. **(See Diagram #3)**

Diagram #3

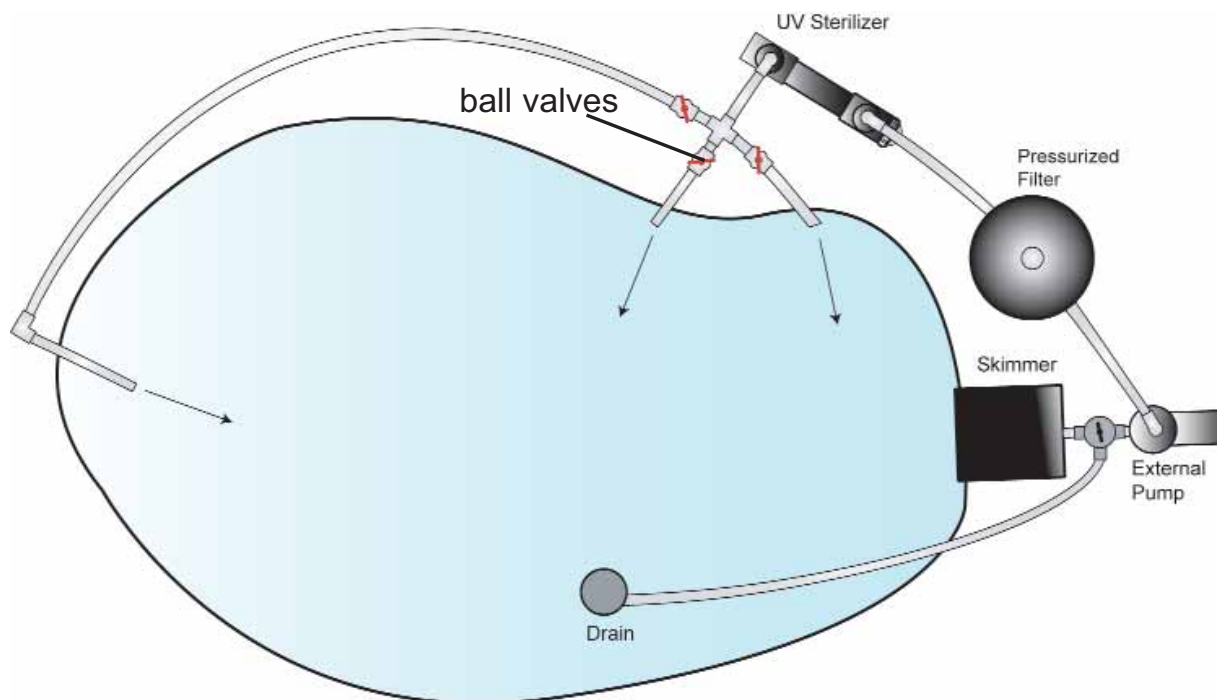

The SMART UV is positioned after the mechanical filter where it can receive only solid waste free water, optimizing UV transmittance/performance. Notice the 3-way valve that regulates suction from the skimmer and drain to the pump, allowing flow control. Next, multiple "clean water returns" improve circulation in the pool suspending solid waste and helping it to find the filter. If you have a flow rate that exceeds the UV's, install a by-pass manifold. **(See Diagram #2)**

Note: Before gluing pipe or a reducer bushing into the UV's union or socket, remove the quartz sleeve assembly to prevent glue from dripping onto the quartz sleeve. Use Teflon tape on all threaded connections.

12-2A Canister Filter/Aquarium Installation

Pressurized Canister filters are commonly used with small freshwater/saltwater aquariums. This diagram shows our EA SMART UV Lite model. It is important to match the Canister Filter's flow rate to the capacity of the SMART UV. If this is not feasible, use a by-pass manifold (See Diagram #6 on pg. 25). To prevent back-siphoning, consider installing a check valve or ball valve (see filter manufacturer's instructions/recommendations). **(See Diagram #4)**

Diagram #4

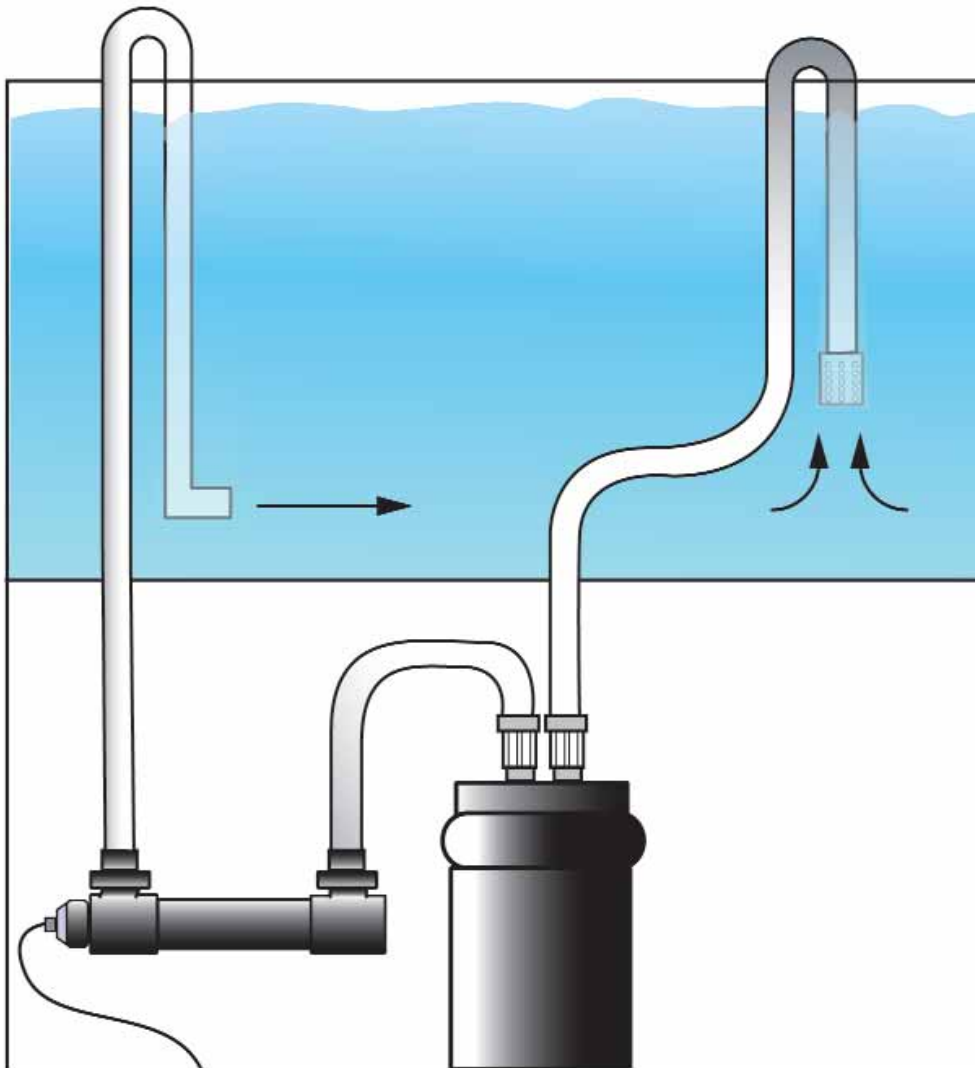

Note: Before gluing pipe or a reducer bushing into the UV's union or socket, remove the quartz sleeve assembly to prevent glue from dripping onto the quartz sleeve. Use Teflon tape on all threaded connections.

12-2B Wet-Dry w/External or Submersible Pump Installation

This installation configuration shows the SMART UV capacity matched to the recirculating flow rate performance of the pump. We recommend mechanical filter media being used inside the over-flow and at the top of the wet-dry filter.

Installing a check valve after the UV will eliminate back siphoning. Installing true-union ball valves will allow flow adjustments and UV removal. For best results, install a saddle-style water flow meter, mounted horizontally on the outlet side of the UV. Follow the water flow meter manufacturer's instructions for proper installation and operation. **(See Diagram #5)**

Diagram #5

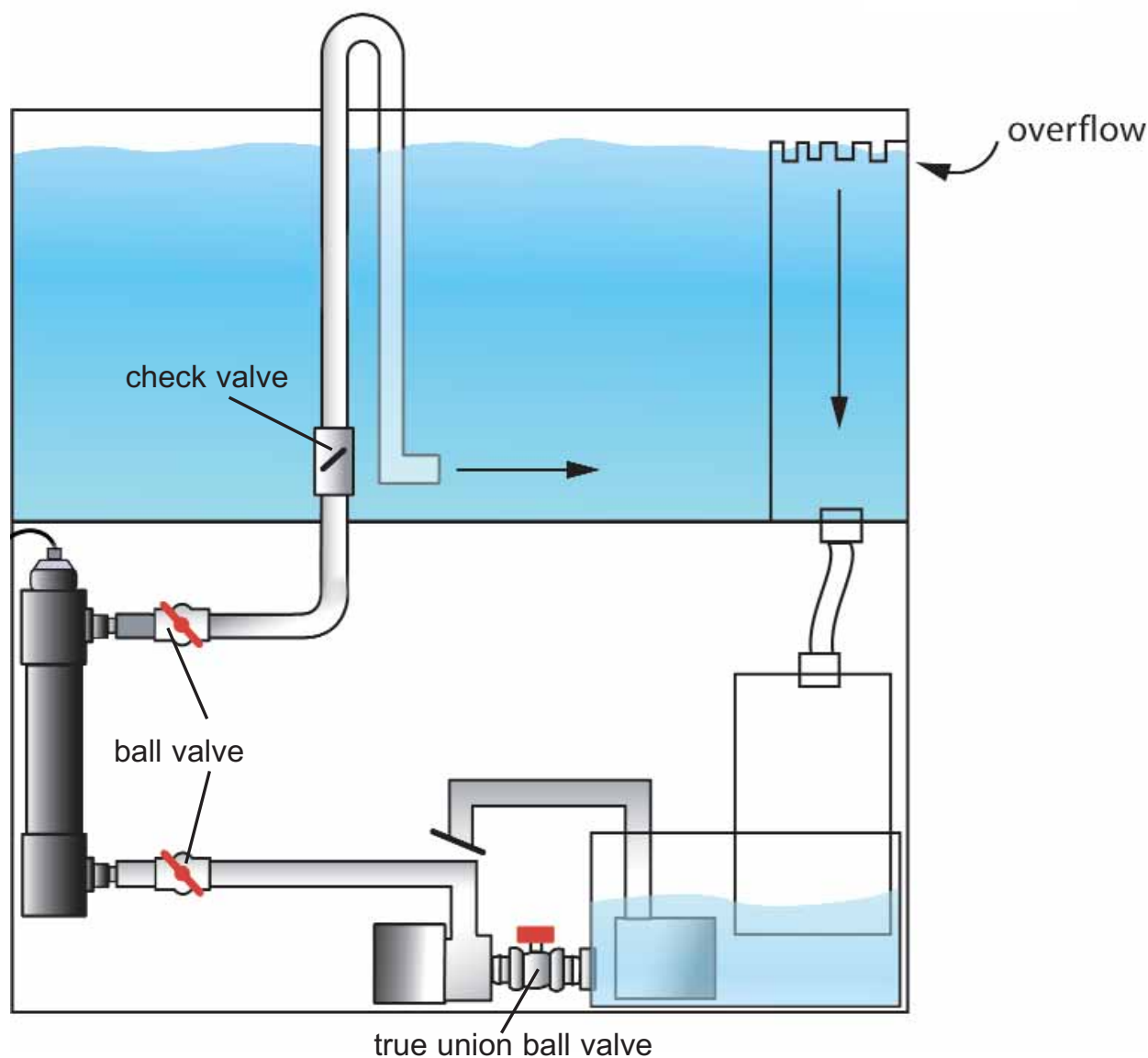

Note: Before gluing pipe or a reducer bushing into the UV's union or socket, remove the quartz sleeve assembly to prevent glue from dripping onto the quartz sleeve. Use Teflon tape on all threaded connections.

12-2C Wet-Dry w/External or Submersible Pump Installation

This installation configuration is identical to diagram 12-2B with the addition of a bypass manifold. The bypass is used to deliver a precise water flow to the SMART UV when the overall clean water return flow rate exceeds the UV's capacity.

Installing a check valve after the UV will eliminate back siphoning. Installing true-union ball valves will allow flow adjustments and easy UV removal for servicing. For best results, install a saddle-style water flow meter, mounted horizontally on the outlet side of the UV. Follow the water flow meter manufacturer's instructions for proper installation and operation. (See Diagram #6)

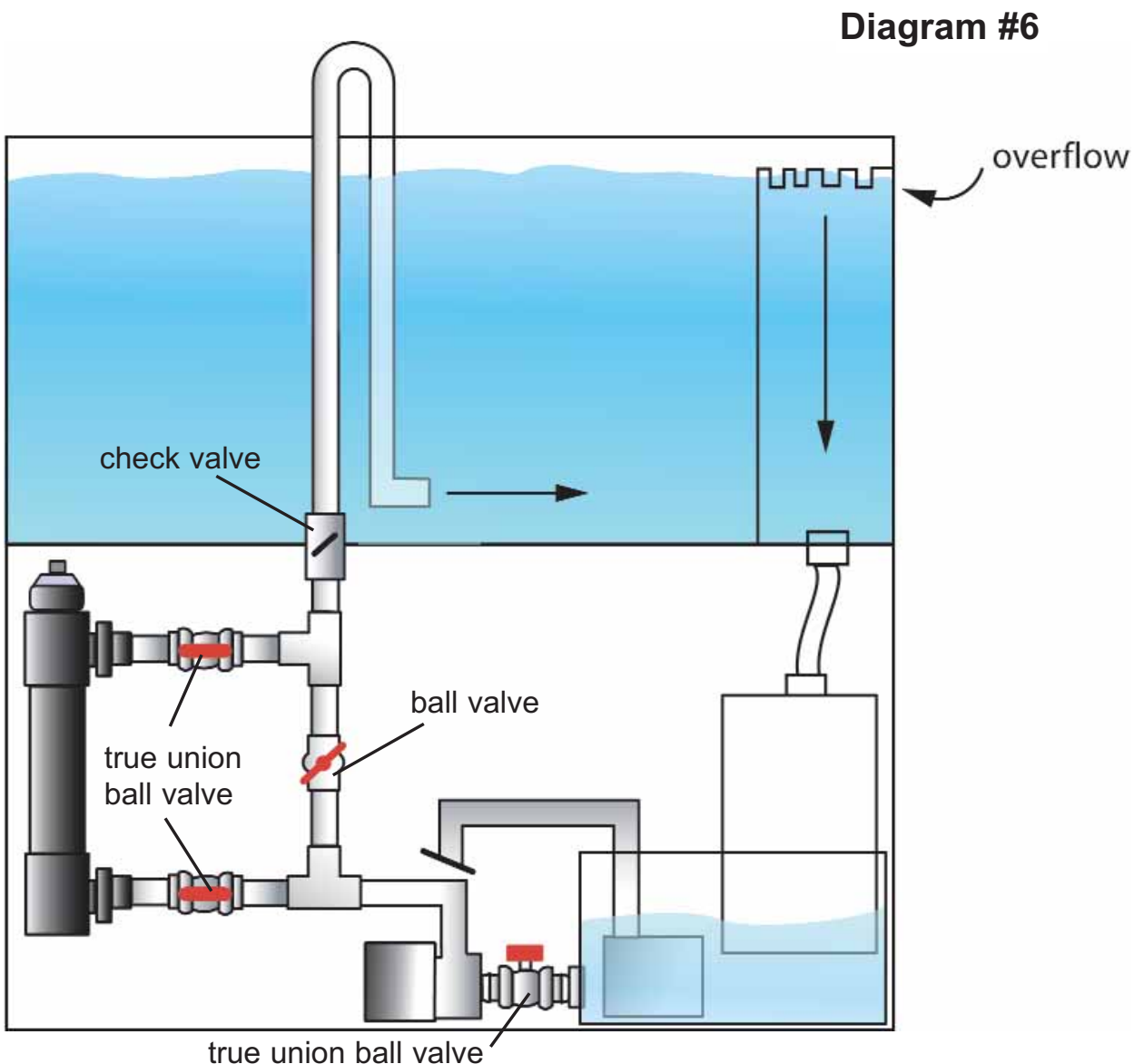

Note: Before gluing pipe or a reducer bushing into the UV's union or socket, remove the quartz sleeve assembly to prevent glue from dripping onto the quartz sleeve. Use Teflon tape on all threaded connections.

Section Thirteen: SMART UV Winterizing

13-1 Winterizing: Using the SMART UV in extremely cold temperatures can cause damage to the unit, especially if the water is allowed to freeze inside the equipment. Please note that damage to the product in this manner is not covered under warranty.

13-2 We recommend shutting the SMART UV down when the temperature consistently falls below 50 degrees.

13-3 Drain and remove the SMART UV from the filtration system.

13-4 Disassemble the entire unit and carefully clean both the outside and interior of the SMART UV body and components.

13-5 Once clean and dry, store the SMART UV in a dry place for the winter. Return the SMART UV to service when temperatures consistently return to 50 degrees or greater. Be sure to replace the quartz sleeve gasket/o-ring and perform a water test prior to operating the equipment. (See Section 6, 8, and 11)

Section Fourteen: SMART UV Maintenance

14-1 Quartz Sleeve Cleaning: We recommend that the UV's quartz sleeve be visually checked for cleaning once every three months of operation. Be aware that even the slightest layer of material (slime/dirt) coated on the outside of the quartz sleeve can have a profound affect on UV-C light transmittance through the glass and into the water. Cleaning frequency is dependent on how well you are filtering the water (solids removal) prior to the UV.

To clean the quartz sleeve, unplug the UV and shut the water pump off. Next, unthread the UV's black retaining nut and gently remove the quartz sleeve assembly and lamp from the UV housing. Inspect the quartz sleeve and clean as needed with a soft, clean cloth. For calcium deposits, use vinegar or muriatic acid to dissolve/clean. Be sure to remove any cleaners or acid before reassembling the quartz sleeve assembly and lamp back into the UV housing.

14-2 UV lamps need to be replaced after 13 months (9,000 hours.) of continual use.

14-3 Lamp Connector Removal: In the event that you would need to replace your 4-pin lamp connector follow these steps:

1. Unplug unit from power source.
2. Remove lamp from unit.
3. Unplug lamp from connector/power cord.



4. Grasp the white 4-pin lamp connector with a pair of pliers while standing on the power cord itself.
5. Pull hard, the connector will come off.
6. Check to make sure the ends of electrical wires are still tinned; they are pre-soldered before they're pushed into the connector. If they are no longer tinned you will need to dip them in some flux and then solder to make them firm enough to push back in new lamp connector. (**Note:** Clean away any residual flux off of the wires before assembling them into the lamp connector.)
7. Using a "new" 4-pin lamp connector, push the power cord's tinned wires into the holes of the connector making sure that they are firmly attached. Once attached, the wires should not pull out of the connector. (See diagrams below for wire placement).
8. Plug lamp back into connector.
9. When installing the lamp be sure to have black jamb nut all the way back on gray adapter. Tighten down the gray adapter first and then secure the black jamb nut. (See Section Ten)

IMPORTANT: If you do not have the black jamb nut back far enough before tightening the gray adapter, the gray adapter will not make contact with the power supply gasket and damage from outside moisture may occur.



For this style power supply use wire configuration A.



For this style power supply use wire configuration B.

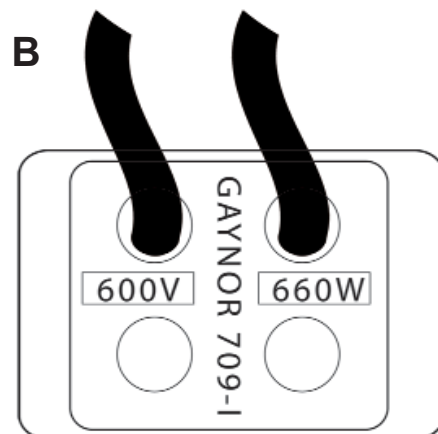
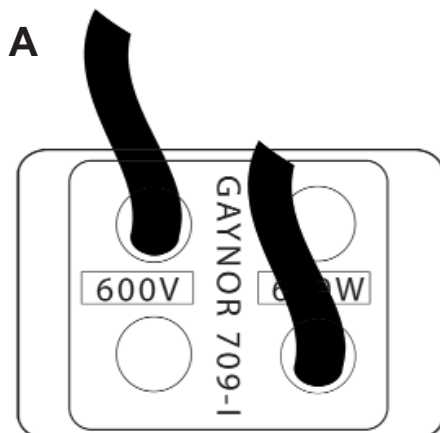

Section Fifteen: SMART UV Replacement Parts

EMPEROR AQUATICS, INC.

SMART UV LITE STERILIZERS EXPLODED PARTS VIEW DIAGRAM

FOR MODEL #'s 02218, 02225, 02240, & 02280 UV STERILIZERS &
FOR MODEL #'s 02218-W, 02225-W, 02240-W, & 02280-W UV STERILIZERS

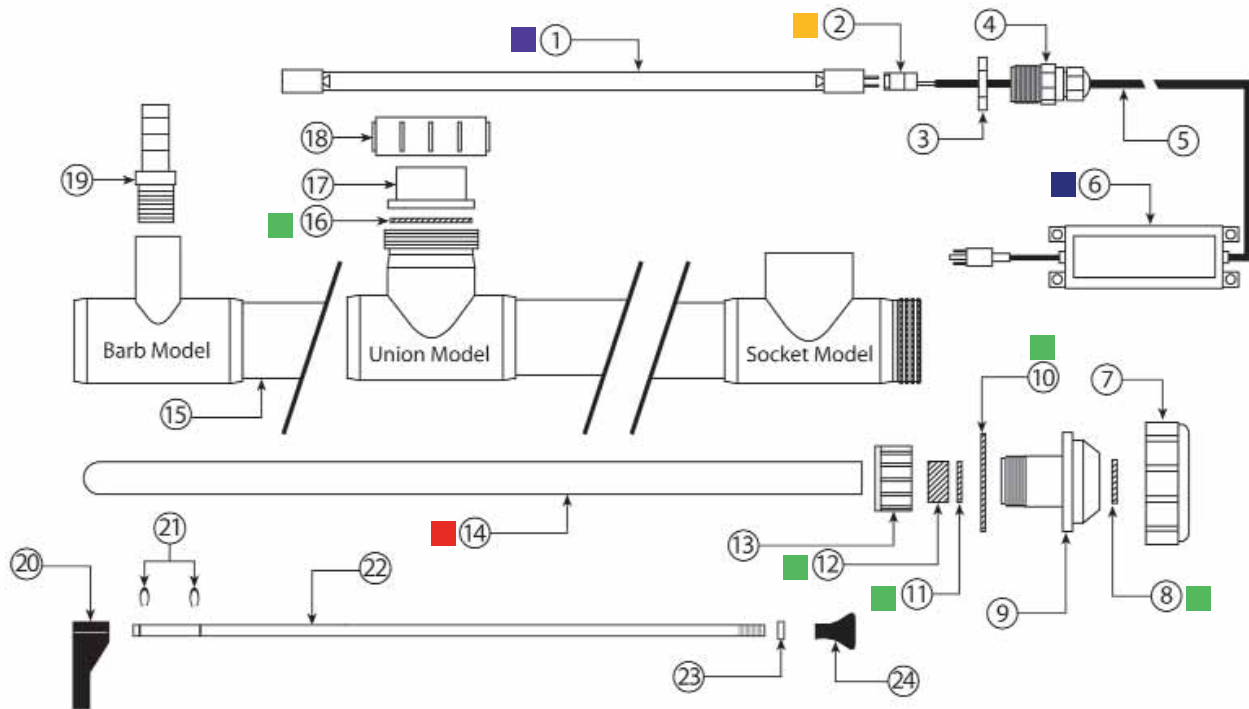

1. UV Lamp
2. 4-Pin Lamp Connector
3. Black Power Supply Jamb Nut
4. Gray Power Supply Adapter
5. Power Supply Cord
6. Power Supply Module Assembly
7. Black Retaining Nut
8. Power Supply Gasket
9. Clear Quartz Sleeve Retaining Module
10. O-Ring for Clear Quartz Sleeve Retaining Module
11. Quartz Sleeve O-Ring
12. Quartz Sleeve Gasket
13. White Quartz Sleeve Gasket/O Ring Retaining Nut
14. Quartz Sleeve
15. UV Sterilizer Housing
16. Water Inlet/Outlet Union O-Ring (used on union models only)
17. Water Inlet/Outlet Union Socket Half (used on union models only)
18. Water Inlet/Outlet Union Retaining Nut (used on union models only)
19. Hose Barb Insert (used on hose barb models only)
20. Quartz Sleeve Wiper Module (only w/ Wiper models)
21. C-Clips (only w/ Wiper models)
22. Quartz Sleeve Wiper Rod (only w/ Wiper models)
23. Wiper Rod Handle Stop Nut (only w/ Wiper models)
24. Wiper Rod Handle (only w/ Wiper models)

SMART UV Lite Watts/Model No.	UV Lamp Part No.	Quartz Sleeve Part No.	Power Supply Part No.	Lamp Connector Part No.	Fittings/Mounting Clamps Kit Part No. for 1.5" Unions/2" Socket	Gasket Service Kit Part No.
18 Watt/02218	20018	20318	20225/20100	20077	20061/20062	20624
25 Watt/02225	20025	20325	20225/20100	20077	20061/20062	20624
40 Watt/02240	20040	20340	20100	20077	20061/20062	20624
80 Watt/02280	20040 x 2	20340 x 2	20100 x 2	20077 x 2	20061 x 2/20062 x 2	20625

NOTE: Clear Quartz Sleeve Retaining Module #20622, White Quartz Sleeve Retaining Nut #20079, both fit all SMART UV Lite Models; two required for #02280

EMPEROR AQUATICS, INC.

SMART UV STERILIZERS EXPLODED PARTS VIEW DIAGRAM

FOR MODEL #'s 02025, 02040, & 02065 UV STERILIZERS &
FOR MODEL #'s 02025-W, 02040-W, & 02065-W UV STERILIZERS

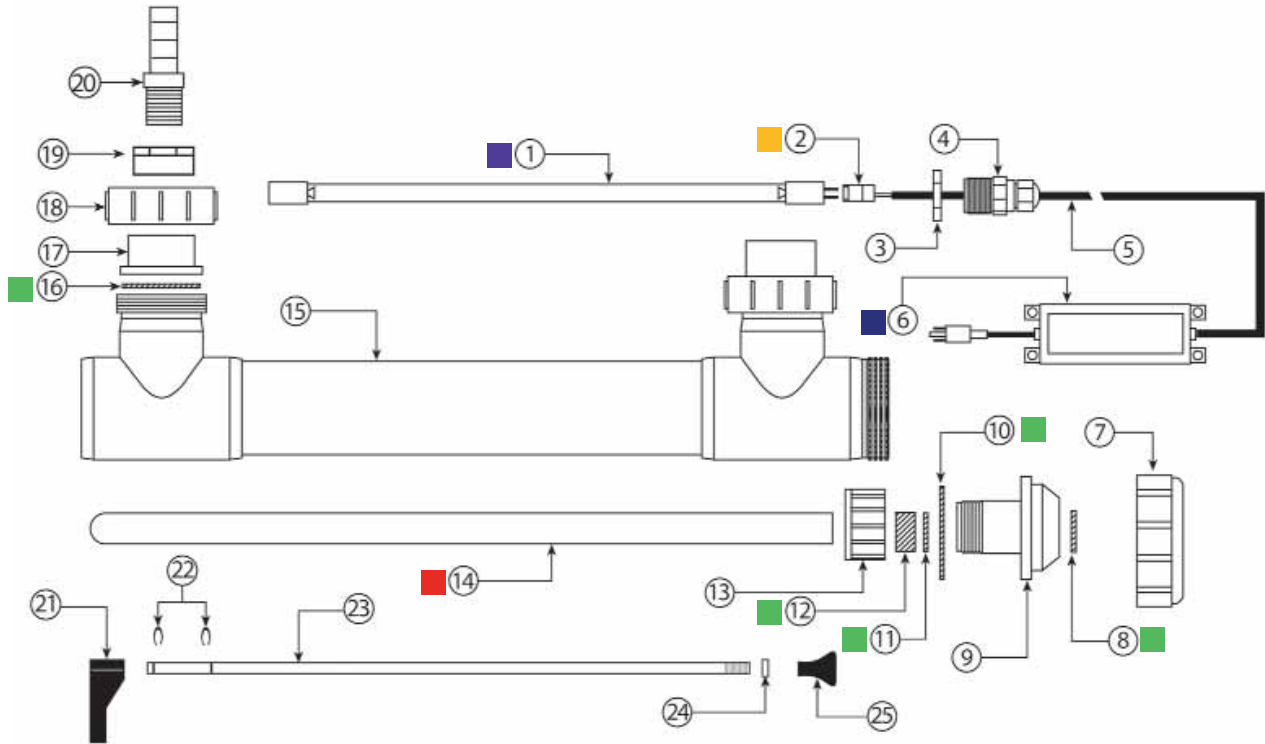

1. UV Lamp
2. 4-Pin Lamp Connector
3. Black Power Supply Jamb Nut
4. Gray Power Supply Adapter
5. Power Supply Cord
6. Power Supply Module Assembly
7. Black Retaining Nut
8. Power Supply Gasket
9. Clear Quartz Sleeve Retaining Module
10. O-Ring for Clear Quartz Sleeve Retaining Module
11. Quartz Sleeve O-Ring
12. Quartz Sleeve Gasket
13. White Quartz Sleeve Gasket/O-Ring Retaining Nut
14. Quartz Sleeve
15. UV Sterilizer Housing
16. Water Inlet/Outlet Union O-Ring
17. Water Inlet/Outlet Union Socket Half
18. Water Inlet/Outlet Union Retaining Nut
19. Water Inlet/Outlet Union Reducer Bushing (Optional Fitting Included)
20. Water Inlet/Outlet Union Threaded Hose Barb (Optional Fitting Included)
21. Quartz Sleeve Wiper Module (only w/ wiper models)
22. C-Clips (only w/ wiper models)
23. Quartz Sleeve Wiper Rod (only w/ wiper models)
24. Wiper Rod Handle Stop Nut
25. Wiper Rod Handle

SMART UV Watts/Model No.	UV Lamp Part No.	Quartz Sleeve Part No.	Power Supply Part No.	Lamp Connector Part No.	Mounting Clamps Kit Part No. for 1.5" Unions	Gasket Service Kit Part No.
25 Watt/02025	20025	20325	20225/20100	20077	20302	20375
40 Watt/02040	20040	20340	20100	20077	20302	20375
65 Watt/02065	20065	20365	20100	20077	20302	20375
80 Watt/02080	20040 x 2	20340 x 2	20100 x 2	20077 x 2	20302 x 2	20376
130 Watt/02130	20065 x 2	20365 x 2	20100 x 2	20077 x 2	20302 x 2	20376

NOTE: Clear Quartz Sleeve Retaining Module #20603, White Quartz Sleeve Retaining Nut #20079, both fit all SMART UV Sterilizer Models; two required for #02080, #02130

EMPEROR AQUATICS, INC.
SMART UV STERILIZER EXPLODED PARTS VIEW DIAGRAM
 FOR 80 & 130 WATT UV STERILIZERS
 MODELS #02080 & 02130 & MODELS #02080-W & 02130-W

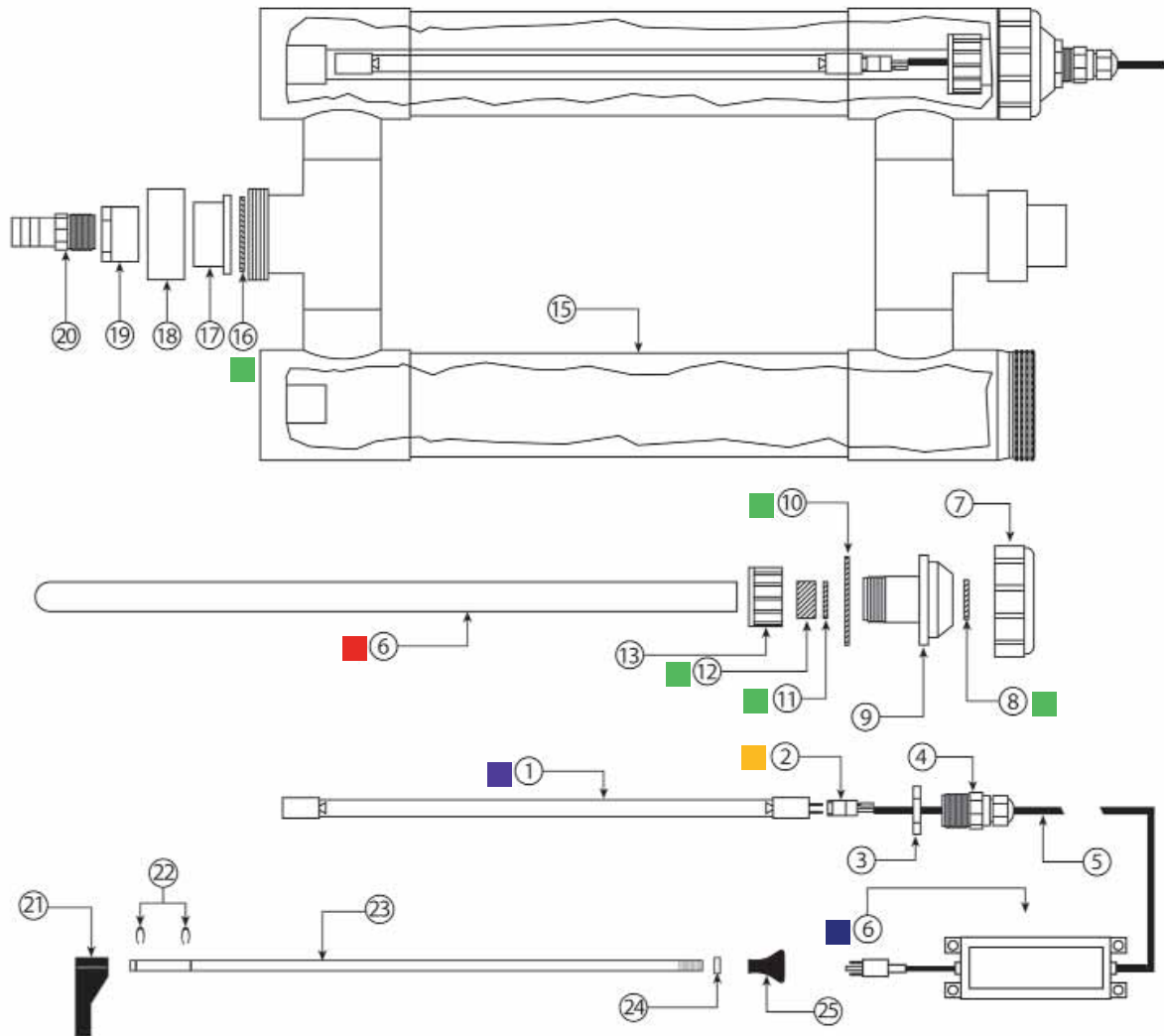

- | | |
|---|--|
| <ol style="list-style-type: none"> 1. UV Lamp 2. 4-Pin Lamp Connector 3. Black Power Supply Jamb Nut 4. Gray Power Supply Adapter 5. Power Supply Cord 6. Power Supply Module Assembly 7. Black Retaining Nut 8. Power Supply Gasket 9. Clear Quartz Sleeve Retaining Module 10. O-Ring for Clear Quartz Sleeve Retaining Module 11. Quartz Sleeve O-Ring 12. Quartz Sleeve Gasket 13. White Quartz Sleeve Gasket/O-Ring Retaining Nut 14. Quartz Sleeve 15. UV Sterilizer Housing | <ol style="list-style-type: none"> 16. Water Inlet/Outlet Union O-Ring 17. Water Inlet/Outlet Union Socket Half 18. Water Inlet/Outlet Union Retaining Nut 19. Water Inlet/Outlet Union Reducer Bushing (optional fitting included) 20. Water Inlet/Outlet Union Threaded Hose Barb (optional fitting included) 21. Quartz Sleeve Wiper Module (only with Wiper models) 22. C-Clips (only w/ wiper models) 23. Quartz Sleeve Wiper Rod (only w/ wiper models) 24. Wiper Rod Handle Stop Nut 25. Wiper Rod Handle |
|---|--|

(See chart on pg. 29 for part numbers)

EMPEROR AQUATICS, INC.

SMART HO UV STERILIZERS EXPLODED PARTS VIEW DIAGRAM

FOR MODEL #'s 025050, 025080, 025120, & 025150 UV STERILIZERS &
FOR MODEL #'s 025050-W, 025080-W, 025120-W, & 025150-W UV STERILIZERS

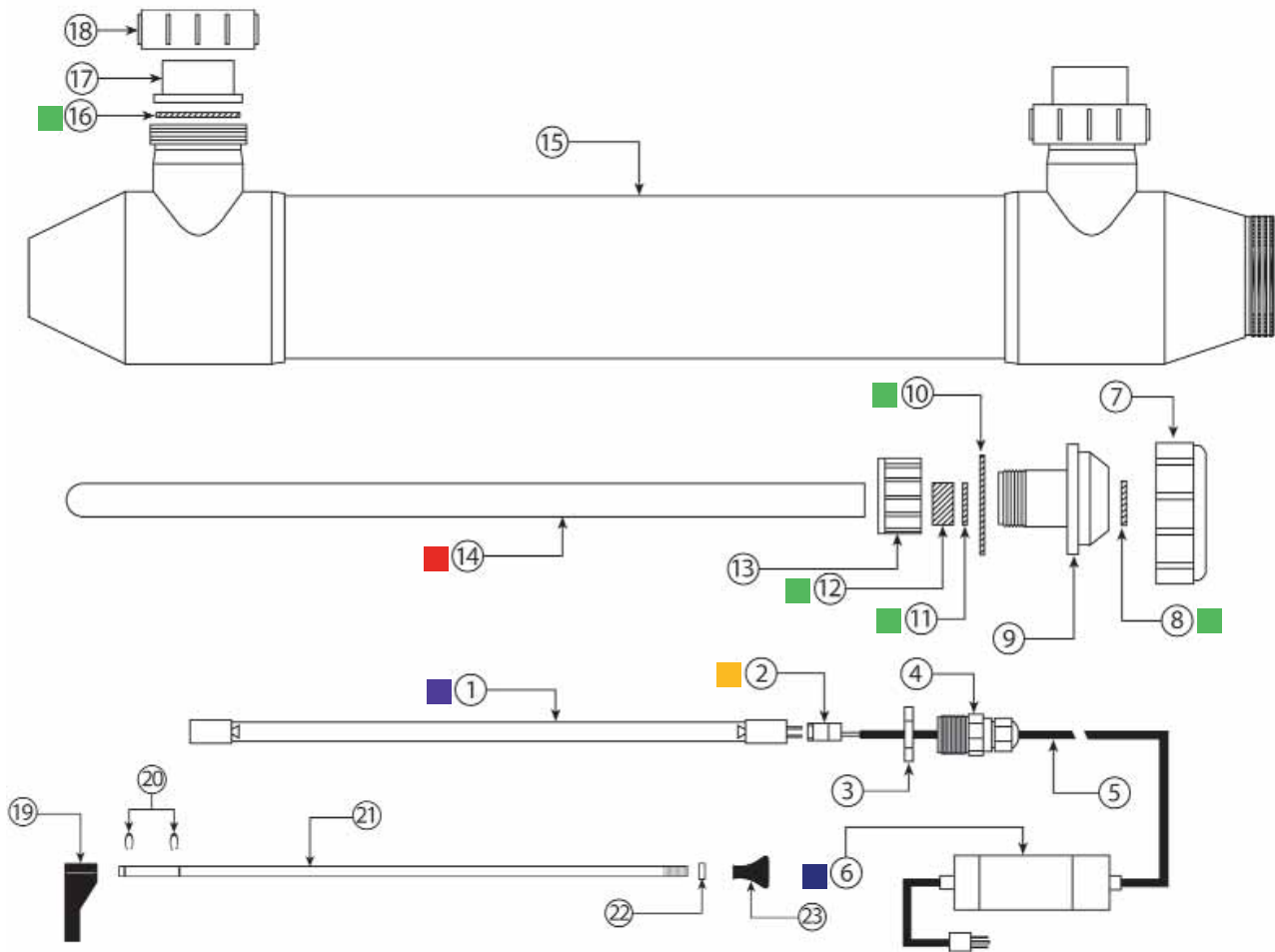

- | | |
|---|--|
| 1. UV Lamp | 13. White Quartz Sleeve Gasket/O-Ring |
| 2. 4-Pin Lamp Connector | Retaining Nut |
| 3. Black Power Supply Jamb Nut | 14. Quartz Sleeve |
| 4. Gray Power Supply Adapter | 15. UV Sterilizer Housing |
| 5. Power Supply Cord | 16. Water Inlet/Outlet Union O-Ring |
| 6. Power Supply Module Assembly | 17. Water Inlet/Outlet Union Socket Half |
| 7. Black Retaining Nut | 18. Water Inlet/Outlet Union Retaining Nut |
| 8. Power Supply Gasket | 19. Quartz Sleeve Wiper Module (w/ wiper only) |
| 9. Clear Quartz Sleeve Retaining Module | 20. C-Clips (w/ wiper only) |
| Retaining Module | 21. Quartz Sleeve Wiper Rod (w/ wiper only) |
| 10. O-Ring for Clear Quartz Sleeve | 22. Wiper Rod Handle Stop Nut (w/ wiper only) |
| Retaining Module | 23. Wiper Rod Handle (w/ wiper only) |
| 11. Quartz Sleeve O-Ring | |
| 12. Quartz Sleeve Gasket | |

SMART HO UV Watts/Model No.	UV Lamp Part No.	Quartz Sleeve Part No.	Power Supply Part No.	Lamp Connector Part No.	Gasket Service Kit Part No.
50 Watt/025050	20050	20325	20105/20250-1	20077	20375
80 Watt/025080	20080	20340	20105/202120-1	20077	20375
120 Watt/025120	200120	203120	20105/202120-1	20077	20375
150 Watt/025150	200150	20365	202150-1	20077	20375

NOTE: Clear Quartz Sleeve Retaining Module #20603, White Quartz Sleeve Retaining Nut #20079, both fit all SMART UV Sterilizer Models as well as all SMART HO UV Sterilizers.

Section Sixteen: SMART UV Troubleshooting

1. Paper towel test indicates a leak - Turn off pump water flow to unit. Refer to Section 6 & 10 (in reverse order) to disassemble unit. Reassemble Quartz Sleeve following Section 6 and repeat the water test (See Section Eight) until there are no indications of a leak. Key items to look for include the Quartz Sleeve for possible breakage/cracks, Quartz Sleeve Gasket and O-ring improper placement, and if the white quartz sleeve retaining nut is tightened down completely.

2. GFI/Breaker is tripping - Immediately unplug the SMART UV and turn off all water flow to the unit. Follow section 6 & 10 (in reverse order) to disassemble the UV and check for water/moisture inside the quartz sleeve.

Consider that multiple appliances plugged into a branch of outlets that are protected by one GFI create the potential for cumulative leakage current resulting in a tripped GFI. See section 9-5 for a more detailed explanation.

3. Pond still green after a week with UV Operation?

Check to make sure the lamp is lit by utilizing the safe viewing port. Is the Quartz Sleeve dirty? Double check the flow rate through the unit and compare this to our flow rate chart for your specific model. To determine your flow rate, place a bucket of known capacity at the water return and time how long it takes to fill the container. Our SMART UV flow rates are listed in Gallons per Hour. To compare, follow the provided example: a 5 gallon bucket fills up in 20 seconds. Divide the 20 seconds into 60 (1 minute) = 3 to calculate your gallon per minute rate. In this case, 3 x 5 gallons (1 bucket full) = 15 GPM. Multiply this by 60 (minutes in an hour) to get 900 GPH.

Section Seventeen: Contact Information

This is a recommended list of who to call if you have a question.

I inspected my UV after I brought it home from the store and the glass is broken or cracked. Please call the Store from which the unit was purchased.

I have an issue with my UV and I'm not sure if it's under Warranty. Please call us at 610-970-0440 x0

I'm not sure my UV is working properly. Please call EMPEROR AQUATICS, INC. at 610-970-0440 x0

How do I connect my UV to the rest of my system? Please call the store from which the unit was purchased OR Contact your local Pond Contractor

If you have any questions regarding anything listed within this instruction booklet, please call EMPEROR AQUATICS, INC. at 610-970-0440 x0

SERVICE AND REPAIR

Your retailer or distributor is not an authorized service or repair center! If trouble develops, do not take the unit back to your retail store. Instead, call Emperor Aquatics Inc. at (610)-970-0440 x0 to discuss the problem then if necessary we will give you an RMA number, so you may return the unit to us for proper service. After being given an RMA number carefully pack the unit up to avoid shipping damage. Send the unit to the following address:

**EMPEROR AQUATICS INC.
2229 SANATOGA STATION RD.
POTTSTOWN, PA 19464**

DO NOT RETURN ANY PRODUCT WITHOUT PRIOR AUTHORIZATION

Be sure to insure your package prior to shipping it; clearly indicate the problem on paper and place it in the box. Please provide your return address, as well as a day-time phone number where you can be reached. Upon receipt of your unit, we will repair or replace the unit (at no charge if the warranty is still in effect, proof of date of purchase will be required) or call/send you an estimate of the cost of the repairs which requires your authorization in order for us to proceed.

WARRANTY

EMPEROR AQUATICS, INC. warrants to the original purchaser of its Ultraviolet Sterilizers to be free from defects in workmanship or materials for a period of twelve (12) months from the date of purchase on the power supply and all gasket seals. A lifetime warranty is offered on the UV Sterilizer's plastic main body housing due to failure of the plastic from UV light exposure and 90 days on the UV lamp for electrical operation only. The UV lamp and the Quartz Sleeve are not warranted against breakage due to their glass construction. The equipment must be installed in accordance with the factory instructions & operated within the environment and limitations for which it was designed for warranty coverage. Should any of the integral parts of the unit become defective within their time constraints from the date of purchase, they will be repaired or replaced, if proven defective in workmanship or material in the opinion of the manufacturer, This does not include damage by freezing or the reuse of gasket seals that are more than twelve (12) months old.

Any costs incurred for the labor of removing the unit shall be the responsibility of the original purchaser, as will be all shipping charges to and from Emperor Aquatic's Inc. factory. Any non-warranty repair will be billed at a per hour rate, call for current rate with a minimum of 1 hour plus the cost of the parts. Damage or failure of any part of the UV Sterilizer covered by this warranty, which results from causes, directly or indirectly, connected with the installation, operation, environment, use or willful abuse, including, without limitation, improper packaging and damage incurred during shipping is not covered by this warranty. Otherwise, any implied warranties, which accompany the sale of these goods, are limited to their respective time constraints from the date of purchase. The manufacturer will only be responsible for the repair or replacement of any of its products or parts there of that are found to be defective and will not bear the cost of any incidental or consequential damages arising out of the occurrence of such a defect.

Other Emperor Aquatics, Inc. Products



Model # - 01782
& 01786

Each bioPRO features our unique Bio Cell bio media; specifically designed for bio-filtration. This neutrally buoyant, "high impact" polystyrene media provides a large amount of surface area that is required for healthy colonies of aerobic nitrifying bacteria. Bio Cell's design combine self-cleaning with protected surface area, enhancing and protecting nitrifying bacteria growth. The result: a biological filter specifically engineered to deliver robust biofiltration...easy to install...easy to operate!



Our Advanced UV for SAVIO Skimmers is available in 18, 25 and 50 watt. This new UV was created to work with the Savio skimmer's new interior design, which was released in early 2007.



Model # - 02826

The ORIGINAL RETRO-FIT UV™ for SAVIO Skimmers

Our Original Retro-Fit UV for SAVIO Skimmers is available in 16, 25 and 57 watt. All Retro-Fit UVs utilize our "Hard Quartz" glass UV lamps which deliver 13 months of continual use until reaching 80% efficiency.



Model # - 02825

TADPOLE UV™

A complete submersible filter system for ponds up to 1,000 gallons

- Submersible, no plumbing
- Efficient & Easy to clean
- 500 GPH water pump
- Internal 25 watt UV
- Durable Construction

Model # - 01725



TADPOLE™

Combine with a SMART UV for complete "small" pond filtration



Model # - 01703 & 01705

- Large surface area for efficient solid waste capture
- Easily attaches to the suction end of water pump using standard PVC fittings
- Keeps pumps, fountains, UVs and filters free of clogging
- Easy to install and clean

HydraPAK™

HydraPAK systems combine exceptional solid waste capture/removal with efficient UV protection against nuisance waterborne algae and harmful bacteria. Each component of the HydraPAK is specifically matched to provide dependable operating performance. They are best suited for ornamental ponds/water features, mammal/reptile exhibits and fish culture systems. Turn-key system; complete and ready to go.



Model # - EAK-2

Notes:

Register Online at:

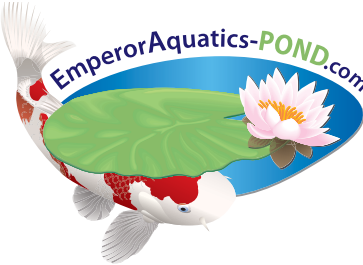

www.emperoraquatics.com

2229 Sanatoga Station Road Pottstown, PA 19464
Phone: 610-970-0440 | Fax: 610-970-0443
Email: info@emperoraquatics.com

OWNER'S REGISTRATION OF EQUIPMENT

FOR YOUR WARRANTY TO BE VALID YOU MUST SUBMIT A FILLED OUT INFORMATION CARD OR COMPLETE AN ONLINE REGISTRATION FORM WITHIN 30 DAYS OF PURCHASE.

PURCHASER'S NAME: _____

PHONE #: _____ **FAX #:** _____

STREET ADDRESS: _____

CITY: _____ **STATE:** _____ **ZIP:** _____

SERIAL #: _____ **MODEL #:** _____ **PURCHASE DATE:** _____

EMAIL ADDRESS: _____

(PLEASE PRINT)

HOW DO YOU LIKE OUR PRODUCT?

We at Emperor Aquatics take your comments about our products very seriously. Please take a few moments to answer these questions and return this form with your product registration.

1. Was this product packaged well? _____

2. Did you receive all of the parts and instructions with the unit?

3. Were the instructions easy to understand?

4. Were you satisfied with the quality of the product?

5. Are you satisfied with the product's performance?

6. Would you recommend our products to someone else?

7. Where did you purchase the unit?

8. What did you pay for the unit? _____

9. Application

Pond

Aquarium

Other _____