

Wastewater

6 Series



Applications

- Little Giant 6 Series Sump Pumps are rated for continuous duty in basement sump, dewatering and water transfer applications

Features

- 1/3 hp shaded pole motor with thermal overload protection
- Oil-filled motor housing
- Cast iron pump housing with protective epoxy coating for corrosion resistance
- 1-1/2" FNPT discharge
- Stainless steel screws, bolts and handle
- Mechanical seal (stainless steel spring, nitrile parts, carbon and ceramic faces)
- Upper and lower sintered sleeve bearings
- Manual and automatic models
- PVC leg kit lifts the pump off the bottom of the basin to help keep the intake screen free of debris (Included with item 506162 only)
- Automatic operation with integral diaphragm switch:
 - On level: 7" - 10"
 - Off level: 1" - 4"
(Integral diaphragm switch is non-adjustable)
- Automatic operation with piggyback mechanical float switch:
 - On level: 9" - 10.5"
 - Off level: 2" - 3"
(Pumping range is adjustable)

Engineering Data

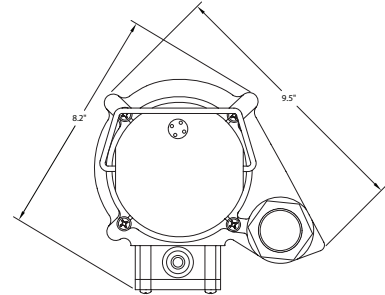
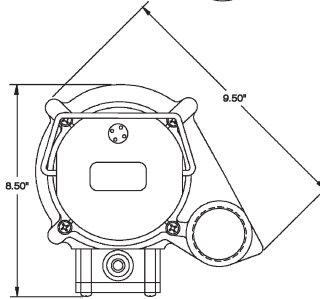
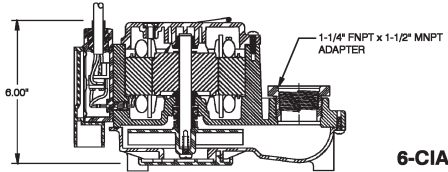
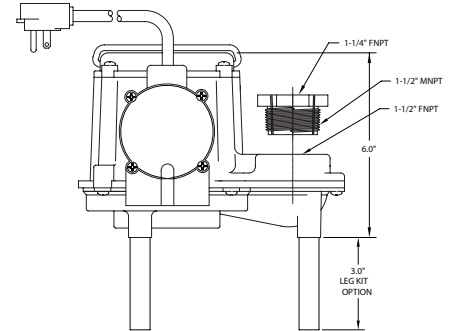
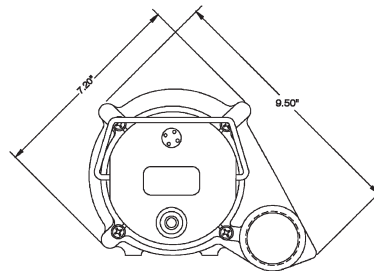
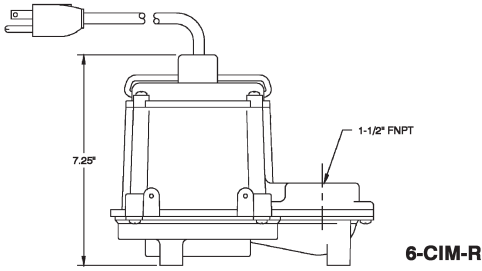

Specifications

Item No.	Model No.	Listing	HP	Volts	Amps	Watts	Flow (GPM @ Head)			Shutoff Head (ft)	P.S.I.	Power Cord (ft)	Weight (lbs)	Dimensions (H x L x W) (in)
							5'	10'	15'					
506271	6-CIM-R	cCSAul	1/3	115	9.0	720	46	29	12.5	18	7.8	10	16.50	7.25 x 9.50 x 7.25
506274	6-CIM-R	cCSAul	1/3	115	9.0	720	46	29	12.5	18	7.8	25	18.00	7.25 x 9.50 x 7.25
506125	6-CIA	cCSAul	1/3	115	9.0	720	46	29	12.5	18	7.8	25	18.50	6.00 x 9.50 x 8.50
506267	6-CIA-RS*	cCSAul	1/3	115	9.0	720	46	29	12.5	18	7.8	10	17.50	7.25 x 9.50 x 7.25
506266	6-CIM	—	1/3	230	4.5	720	46	29	12.5	18	7.8	12	18.75	6.00 x 9.50 x 8.50
506158	6-CIA	cCSAul	1/3	115	9.0	720	46	29	12.5	18	7.8	10	18.00	6.00 x 9.50 x 8.50
506162	6-CIA***	cCSAul	1/3	115	9.0	720	46	29	12.5	18	7.8	10	18.50	6.00 x 9.50 x 8.50
506166	6-CIA	cCSAul	1/3	230	4.5	720	46	29	12.5	18	7.8	10	18.50	6.00 x 9.50 x 8.50
506171	6-CIA-RFS**	cCSAul	1/3	115	9.0	720	46	29	12.5	18	7.8	10	17.75	7.25 x 9.50 x 7.25

All models are 60 Hz CIM - Manual CIA - Automatic

*Manual pump with RS-5 diaphragm switch included to convert to automatic operation.

**Manual pump with piggyback mechanical float switch included for automatic operation.

***Includes PVC leg kit

Continuous Duty Rated — "Little Giant Wastewater pumps are rated continuous duty as long as they are run within the published ratings for these pumps."

Construction

Cover	Polycarbonate
Motor Housing	Epoxy coated cast iron
Impeller Material	Nylon
Impeller Type	Non-clog
Volute	Polypropylene
Power Cord	18-3, SJOW-A
Mechanical Shaft Seal	Nitrile with carbon and ceramic faces
Fasteners	Stainless steel
Shaft	CRS
Bearings	Upper: Sintered iron/copper, flanged sleeve Lower: Sintered iron/copper, flanged Sleeve

Performance Data

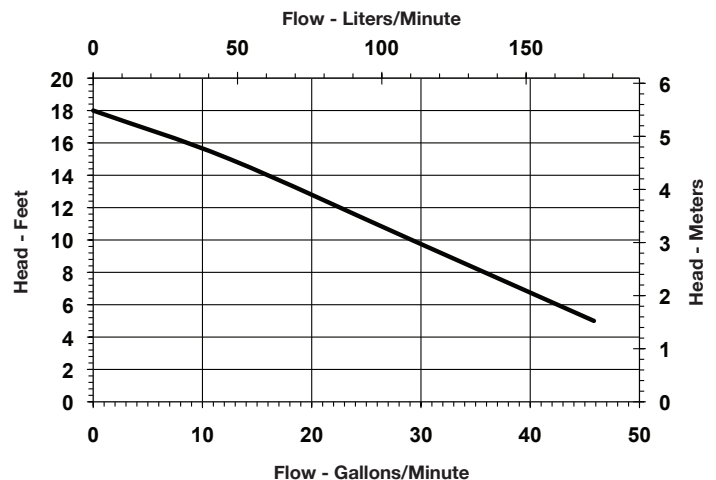

P.O. Box 12010
Oklahoma City, OK 73157-2010
Phone: 1.800.701.7894
Fax: 1.800.678.7867
www.LittleGiantPump.com



©2010 Franklin Electric Co., Inc.
Little Giant® is a registered trademark of Franklin Electric Co., Inc.
Form 995201 — 06/11