



Classic Series

INSTALLATION MANUAL

Table of Contents

Warranty and Service Policy	3
Safety Information	4-5, 18, 31
Pump Identification	6-7
Outputs	8-15
Materials of Construction	16
Accessory Checklist	17
Installation	18-26
Troubleshooting	27-30
Tube Replacement	31-35
Motor – exploded view and parts	36-38
Feed Rate Control – exploded view and parts	39-40
Pump Head – exploded view and parts	41-44
Pump Tubes	45
Check Valves	46
For Your Records	47

CM1207

Warranty and Service Policy

Limited Warranty

Stenner Pump Company will for a period of one (1) year from the date of purchase (proof of purchase required) repair or replace – at our option – all defective parts. Stenner is not responsible for any removal or installation costs. Pump tube assemblies and rubber components are considered perishable and are not covered in this warranty. Pump tube will be replaced each time a pump is in for service, unless otherwise specified. The cost of the pump tube replacement will be the responsibility of the customer. Stenner will incur shipping costs for warranty products shipped from our factory in Jacksonville, Florida. Any tampering with major components, chemical damage, faulty wiring, weather conditions, water damage, power surges, or products not used with reasonable care and maintained in accordance with the instructions will void the warranty. Stenner limits its liability solely to the cost of the original product. We make no other warranty expressed or implied.

Returns

Stenner offers a 30-day return policy on factory direct purchases. Except as otherwise provided, no merchandise will be accepted for return after 30 days from purchase. To return merchandise at any time, call Stenner at 800.683.2378 for a Return Merchandise Authorization (RMA) number. A 15% re-stocking fee will be applied. Include a copy of your invoice or packing slip with your return.

Damaged or Lost Shipments

UPS and prepaid truck shipments: Check your order immediately upon arrival. All damage must be noted on the delivery receipt. Call Stenner Customer Service at 800.683.2378 for all shortages and damages within seven (7) days of receipt.

Service & Repairs

Before returning a pump for warranty or repair, remove chemical from pump tube by running water through the tube, and then run the pump dry. Following expiration of the warranty period, Stenner Pump Company will clean and overhaul any Stenner metering pump for a minimum labor charge plus necessary replacement parts and shipping. All metering pumps received for overhaul will be restored to their original condition. The customer will be charged for missing parts unless specific instructions are given. To return merchandise for repair, call Stenner at 800.683.2378 or 904.641.1666 for a Return Merchandise Authorization (RMA) number.

Disclaimer

The information contained in this manual is not intended for specific application purposes. Stenner Pump Company reserves the right to make changes to prices, products, and specifications at any time without prior notice.

US and Canada 800.683.2378, International 904.641.1666

Safety Information

⚠ WARNING Warns about hazards that **CAN** cause death, serious personal injury, or property damage if ignored.

⚠ ELECTRIC SHOCK HAZARD

⚠ WARNING **ELECTRIC SHOCK HAZARD:**
Pump supplied with grounding power cord and attached plug. To reduce risk of electrical shock, connect only to a properly grounded, grounding type receptacle. Install only on a circuit protected by a ground-fault circuit Interrupter (GFCI).

⚠ AVERTISSEMENT **RISQUE DE CHOC ELECTRIQUE:**
Cette pompe est équipée d'une fiche de mise à terre. Pour réduire le risque de choc électrique, s'assurer que la fiche est bien raccordée à une prise de courant avec une connexion de mise à terre. Installer seulement sur un circuit protéger par un interrupteur protéger par une mise à la terre.

⚠ DO NOT alter the power cord or plug end.

⚠ DO NOT use receptacle adapters.

⚠ DO NOT use pump with a damaged or altered power cord or plug. Contact the factory or an authorized service facility for repair.

⚠ WARNING **HAZARDOUS VOLTAGE:**
DISCONNECT power cord before removing motor cover for service. **Electrical service by trained personnel only.**

⚠ WARNING **EXPLOSION HAZARD:**
This pump is not explosion proof. **DO NOT** install or operate in an explosive environment.

⚠ WARNING **RISK OF CHEMICAL EXPOSURE:**
Potential for chemical burns, fire, explosion, personal injury, or property damage. To reduce risk of exposure, the use of proper personal protective equipment is mandatory.

⚠ WARNING **RISK OF FIRE HAZARD:**
DO NOT install or operate on any flammable surface.

⚠ WARNING **RISK OF CHEMICAL OVERDOSE:**
To reduce risk, follow proper installation methods and recommendations. Check your local codes for additional guidelines.



THIS PRODUCT HAS BEEN
TESTED AND CERTIFIED BY
THE WATER QUALITY ASSOCIATION
ACCORDING TO NSF/ANSI 61 FOR
MATERIALS SAFETY ONLY.

Safety Information continued

⚠ CAUTION Warns about hazards that **WILL** or **CAN** cause minor personal injury or property damage if ignored.

⚠ CAUTION **PLUMBING:**

Chemical feed pump installation must always adhere to your local plumbing codes and requirements. Be sure installation does not constitute a cross connection. Check local plumbing codes for guidelines.

ⓘ NOTICE: Indicates special instructions or general mandatory action.

- ⓘ NOTICE:** This metering pump is portable and designed to be removable from the plumbing system without damage to the connections.
- ⓘ NOTICE:** This metering pump and its components have been tested for use with the following chemicals: Sodium Hypochlorite (10-15%), Muriatic Acid (20-22% Baume, 31.5% Hcl), and Soda Ash.
- ⓘ NOTE:** Cette a pompe de dosage et ses composants ont été testés pour utilisation avec les produits chimiques suivants; Hypochlorite de Sodium (solution de 10-15%); Acide Muriatique (20-22% Baume, 31.5% Hcl); Cendre de Soude.

⚠ This is the safety alert symbol. When displayed in this manual or on the equipment, look for one of the following signal words alerting you to the potential for personal injury or property damage.

- ⚠ PUMP SUITABLE FOR USE OUTDOORS** when installed with a Stenner Rain Roof Part No. MP90000.
- ⚠** Electrical installation should adhere to all national and local codes. Consult a licensed professional for assistance with proper electrical installation.
- ⚠** Removing power from pool/spa recirculation pump must also remove power from pump.
- ⚠** The use of an auxiliary safety device (not supplied), such as a flow switch or sensor, is recommended to prevent feed pump operation in the event of a recirculation pump failure or if flow is not sensed.
- ⚠** Point of chemical injection should be beyond all pumps, filters, and heaters.
- ⚠** Suitable for indoor and outdoor use.
- ⚠** Convient pour usage intérieur et extérieur.

US and Canada 800.683.2378, International 904.641.1666

5

Pump Identification

Box Label

 STENNER PUMP COMPANY Jacksonville, FL Phone: (904)641-1666 MADE IN U.S.A.	
MODEL/MODELO	85MHP5
SERIAL NO./NO. DE SERIAL	02010503943
VOLTAGE/VOLTAJE	120
MAX GPD/MAX LPD	5/18.9 Adjustable Ajustable
PSI/BAR	100/6.9
SUCTION/DISCHARGE TUBING TUBO DE SUCCION/DESCARGA	1/4" White 1/4" Blanco
ITEM NO./NO. DE PARTE	85MJH1A1STAA
www.stenner.com	

Pump Identification continued

Data Label



STENNER PUMP COMPANY
 3174 DeSalvo Road
 Jacksonville, FL 32246 USA
 Phone: 904.641.1666
 www.stenner.com

85MHP5
 MODEL # No. de modelo

85MJH1A1STAA
 ITEM # No. de parte

100 psi / 6.9 bar **120V 60Hz**

1.7 amp **5 gpd / 18.9 lpd**

02010503943 **MADE IN USA**
 SERIAL # No. de serial

Evaluated for use with swimming pools. FL

Warning Label

⚠ (A WARNING) To reduce risk of electric shock, connect only to a properly grounded grounding-type receptacle.

⚠ (A PELIGRO) Para reducir el riesgo de descarga eléctrica, conéctelo a un receptáculo eléctrico con conexión a tierra adecuado.

⚠ CAUTION To reduce risk of electric shock, pull plug before servicing this pump.

⚠ CUIDADO Para reducir el riesgo de descarga eléctrica, desenchufe el dosificador antes de realizar reparaciones.

⚠ (A WARNING) To reduce risk of electric shock, install only on a circuit protected by a ground-fault circuit Interrupter (GFCI).

⚠ (A PELIGRO) Para reducir el riesgo de descarga eléctrica, instale el dosificador en un circuito protegido por un interruptor diferencial.

See installation instructions for overdosing protection.
 Lea las instrucciones de instalación para evitar sobredosis de químicos.

Thermally Protected Motor for Indoor Use.
 Motor termal protegido para el uso interior.

Suitable for Indoor and Outdoor Use.
 Adecuado para el uso interior y exterior.

Nonsubmersible Pump.
 Dosificador no submergible.



ETL
94247

SANITATION LISTED
**CONFORMS TO
 STD. NSF-50**
 CM
 CIRCULATION SYSTEM
 COMPONENTS FOR SWIMMING
 POOLS, SPAS, OR HOT TUBS



METERING PUMP
 LISTED
 96F0



THIS PRODUCT HAS BEEN
 TESTED AND CERTIFIED BY
 THE WATER QUALITY ASSOCIATION
 ACCORDING TO NSF/ANSI 61 FOR
 MATERIALS SAFETY ONLY.



METERING PUMP
 LR79585
 NRTL /C

NOTE: Agency listings vary by model.

US and Canada 800.683.2378, International 904.641.1666

Outputs 45 series

Adjustable Output

Single Head Model	Maximum Pressure	Pump Tube Number	Approximate GPD @ 60Hz										Approximate LPD @ 50Hz											
			Feed Rate Control Setting																					
			L	1	2	3	4	5	6	7	8	9	10	L	1	2	3	4	5	6	7	8	9	10
45MHP2* 45M1	100 psi (6.9 bar) 25 psi (1.7 bar)	#1	0.2	0.3	0.6	0.9	1.2	1.5	1.8	2.1	2.4	2.7	3	0.6	0.9	1.8	2.7	3.6	4.5	5.5	6.4	7.3	8.2	9.1
45MHP10* 45M2	100 psi (6.9 bar) 25 psi (1.7 bar)	#2	0.5	1	2	3	4	5	6	7	8	9	10	1.5	3	6.1	9.1	12.1	15.1	18.2	21.2	24.2	27.3	30.3
45MHP22* 45M3	100 psi (6.9 bar) 25 psi (1.7 bar)	#1 #3	1.1	2.2	4.4	6.6	8.8	11	13.2	15.4	17.6	19.8	22	3.3	6.6	13.3	20	26.6	33.3	40	46.6	53.3	60	66.6
45M4	25 psi (1.7 bar)	#4	1.7	3.5	7	10.5	14	17.5	21	24.5	28	31.5	35	5.1	10.6	21.2	31.8	42.4	53	63.6	74.2	84.8	95.4	106
45M5	25 psi (1.7 bar)	#5	2.5	5	10	15	20	25	30	35	40	45	50	7.6	15.1	30.3	45.4	60.6	75.7	90.8	106	121.1	136.3	151.4

Fixed Output

Single Head Model	Maximum Pressure	Pump Tube Number	GPD 60Hz	LPD 50Hz
45MHP2* 45MP1	100 psi (6.9 bar) 25 psi (1.7 bar)	#1	3	9.1
45MHP10* 45MP2	100 psi (6.9 bar) 25 psi (1.7 bar)	#2	10	30.3
45MHP22* 45MP3	100 psi (6.9 bar) 25 psi (1.7 bar)	#1 #3	22	66.6
45MP4	25 psi (1.7 bar)	#4	35	106
45MP5	25 psi (1.7 bar)	#5	50	151.4

*Pump supplied with injection check valve for 26-100 psi (1.7-6.9 bar) applications



NOTICE: The information within this chart is solely intended for use as a guide. The output data is an approximation based on pumping water under a controlled testing environment. Many variables can affect the output of the pump. Stenner Pump Company recommends that all metering pumps undergo field calibration by means of analytical testing to confirm their outputs.

Outputs 85 series

Adjustable Output

Single Head Model	Maximum Pressure	Pump Tube Number	Approximate GPD @ 60Hz										Approximate LPD @ 50Hz											
			Feed Rate Control Setting																					
			L	1	2	3	4	5	6	7	8	9	10	L	1	2	3	4	5	6	7	8	9	10
85MHP5* 85M1	100 psi (6.9 bar) 25 psi (1.7 bar)	#1	0.3	0.5	1	1.5	2	2.5	3	3.5	4	4.5	5	0.9	1.5	3	4.5	6.1	7.6	9.1	10.6	12.1	13.6	15.1
85MHP17* 85M2	100 psi (6.9 bar) 25 psi (1.7 bar)	#2	0.8	1.7	3.4	5.1	6.8	8.5	10.2	11.9	13.6	15.3	17	2.4	5.1	10.3	15.4	20.6	25.7	30.9	36	41.2	46.3	51.5
85MHP40* 85M3	100 psi (6.9 bar) 25 psi (1.7 bar)	#1 #3	2	4	8	12	16	20	24	28	32	36	40	6.1	12.1	24.2	36.3	48.5	60.6	76.7	84.8	96.9	109	121.1
85M4	25 psi (1.7 bar)	#4	3	6	12	18	24	30	36	42	48	54	60	9.1	18.2	36.3	54.5	76.7	90.8	109	127.2	145.3	163.5	181.7
85M5	25 psi (1.7 bar)	#5	4.3	8.5	17	25.5	34	42.5	51	59.5	68	76.5	85	13	25.7	51.5	77.2	103	128.7	154.4	180	205.9	231.6	257.4

Fixed Output

Single Head Model	Maximum Pressure	Pump Tube Number	GPD 60Hz	LPD 50Hz
85MHP5* 85MP1	100 psi (6.9 bar) 25 psi (1.7 bar)	#1	5	15.1
85MHP17* 85MP2	100 psi (6.9 bar) 25 psi (1.7 bar)	#2	17	51.5
85MHP40* 85MP3	100 psi (6.9 bar) 25 psi (1.7 bar)	#1 #3	40	121.1
85MP4	25 psi (1.7 bar)	#4	60	181.7
85MP5	25 psi (1.7 bar)	#5	85	257.4

*Pump supplied with injection check valve for 26-100 psi (1.7-6.9 bar) applications

NOTICE: The information within this chart is solely intended for use as a guide. The output data is an approximation based on pumping water under a controlled testing environment. Many variables can affect the output of the pump. Stenner Pump Company recommends that all metering pumps undergo field calibration by means of analytical testing to confirm their outputs.

US and Canada 800.683.2378, International 904.641.1666

Outputs '00 series

Adjustable Output

Approximate **GPD @ 60Hz**Approximate **LPD @ 50Hz**

Double Head Model	Maximum Pressure	Pump Tube Number	Approximate GPD @ 60Hz										Approximate LPD @ 50Hz											
			L	1	2	3	4	5	6	7	8	9	10	L	1	2	3	4	5	6	7	8	9	10
100DMHP5* 100DM1	100 psi (6.9 bar) 25 psi (1.7 bar)	#1	0.3	0.6	1.2	1.8	2.4	3.0	3.6	4.2	4.8	5.4	6	0.9	1.8	3.6	5.5	7.3	9.1	10.9	12.7	14.5	16.4	18.2
100DMHP20* 100DM2	100 psi (6.9 bar) 25 psi (1.7 bar)	#2	1	2	4	6	8	10	12	14	16	18	20	3	6.1	12.1	18.2	24.2	30.3	36.4	42.4	48.5	54.5	60.6
100DM3	25 psi (1.7 bar)	#3	2.2	4.4	8.8	13.2	17.6	22	26.4	30.8	35.2	39.6	44	6.7	13.3	26.7	40	53.3	66.6	79.9	93.3	106.6	119.9	133.2
100DM4	25 psi (1.7 bar)	#4	3.5	7	14	21	28	35	42	49	56	63	70	10.6	21.2	42.4	63.6	84.8	106	127.2	148.4	169.6	190.8	212
100DM5	25 psi (1.7 bar)	#5	5	10	20	30	40	50	60	70	80	90	100	15.1	30.3	60.6	90.8	121.1	151.4	181.7	212	242.2	272.5	302.8

Fixed Output

Double Head Model	Maximum Pressure	Pump Tube Number	GPD 60Hz	LPD 50Hz
100DMHP5* 100DMP1	100 psi (6.9 bar) 25 psi (1.7 bar)	#1	6	18.2
100DMHP20* 100DMP2	100 psi (6.9 bar) 25 psi (1.7 bar)	#2	20	60.6
100DMP3	25 psi (1.7 bar)	#3	44	133.2
100DMP4	25 psi (1.7 bar)	#4	70	212
100DMP5	25 psi (1.7 bar)	#5	100	302.8

*Pump supplied with injection check valve for 26-100 psi (1.7-6.9 bar) applications

NOTICE: The information within this chart is solely intended for use as a guide. The output data is an approximation based on pumping water under a controlled testing environment. Many variables can affect the output of the pump. Stenner Pump Company recommends that all metering pumps undergo field calibration by means of analytical testing to confirm their outputs.

Outputs ' 70 series

Adjustable Output

Double Head Model	Maximum Pressure	Pump Tube Number	Approximate GPD @ 60Hz										Approximate LPD @ 50Hz											
			Feed Rate Control Setting																					
			L	1	2	3	4	5	6	7	8	9	10	L	1	2	3	4	5	6	7	8	9	10
170DMHP9* 170DM1	100 psi (6.9 bar) 25 psi (1.7 bar)	#1	0.5	1	2	3	4	5	6	7	8	9	10	1.5	3	6.1	9.1	12.1	15.1	18.2	21.2	24.2	27.3	30.3
170DMHP34* 170DM2	100 psi (6.9 bar) 25 psi (1.7 bar)	#2	1.7	3.4	6	9.5	13.6	17	20.4	23.8	27.2	30.6	34	5.1	10.3	18.2	28.8	39.1	51.5	61.8	72.1	82.4	92.7	102.6
170DM3	25 psi (1.7 bar)	#3	4	8	16	24	32	40	48	56	64	72	80	12.1	24.2	48.5	72.7	96.9	121.1	145.4	169.6	193.8	218	242.2
170DM4	25 psi (1.7 bar)	#4	6	12	24	36	48	60	72	84	96	108	120	18.2	36.3	72.7	109	145.3	181.7	218	254.4	290.7	327	363.4
170DM5	25 psi (1.7 bar)	#5	8.5	17	34	51	68	85	102	119	136	153	170	25.7	51.5	86	154.4	205.9	257.4	308.9	360.4	411.8	463.3	514.8

Fixed Output

Double Head Model	Maximum Pressure	Pump Tube Number	GPD 60Hz	LPD 50Hz
170DMPHP9* 170DMP1	100 psi (6.9 bar) 25 psi (1.7 bar)	#1	10	30.3
170DMPHP34* 170DMP2	100 psi (6.9 bar) 25 psi (1.7 bar)	#2	34	102.6
170DMP3	25 psi (1.7 bar)	#3	80	242.2
170DMP4	25 psi (1.7 bar)	#4	120	363.4
170DMP5	25 psi (1.7 bar)	#5	170	514.8

*Pump supplied with injection check valve for 25-100 psi (1.7-6.9 bar) applications

NOTICE: The information within this chart is solely intended for use as a guide. The output data is an approximation based on pumping water under a controlled testing environment. Many variables can affect the output of the pump. Stenner Pump Company recommends that all metering pumps undergo field calibration by means of analytical testing to confirm their outputs.

US and Canada 800.683.2378, International 904.641.1666

Outputs ' 00MDC series

Determining Output for Dual Head Dual Control Models

- The dial ring for adjustable pumps is marked L-10; L=5%, ' ' 0 indicates approximately 10% increments of maximum output.
- On the MDC models, the outer pump head operates on a percentage of the inner head (closest to the motor).
- Setting #10 on both pump heads will deliver the pump's maximum output and is the only time each pump head will output the same amount.

Example Using 100MDC5

- Decide on the desired output for the inner head.
- Note the setting on the dial ring that represents the desired output.
For example setting #4 = 40% of max output
In the 100MDC5 model, setting #4 = 20 gpd
- Repeat the above steps to calculate the output of the outer head.
Using setting #3 in this example,
#3 = 30% of the inner head output
 $20 \text{ gpd} \times 30\% = 6 \text{ gpd}$

In this example using pump model 100MDC5, the output for the inner head would be 20 gpd and 6 gpd for the outer head.

Outputs '00MDC series

Outputs for Innermost Head Only

Dual Head Dual Control	Maximum Pressure	Pump Tube Number	Approximate GPD @ 60Hz										Approximate LPD @ 50Hz											
			Feed Rate Control Setting																					
			L	1	2	3	4	5	6	7	8	9	10	L	1	2	3	4	5	6	7	8	9	10
100MDCHP5* 100MDC1	100 psi (6.9 bar) 25 psi (1.7 bar)	#1	0.2	0.3	0.6	0.9	1.2	1.5	1.8	2.1	2.4	2.7	3	0.6	0.9	1.8	2.7	3.6	4.5	5.5	6.4	7.3	8.2	9.1
100MDCHP20* 100MDC2	100 psi (6.9 bar) 25 psi (1.7 bar)	#2	0.5	1	2	3	4	5	6	7	8	9	10	1.5	3	6.1	9.1	12.1	15.1	18.2	21.2	24.2	27.3	30.3
100MDC3	25 psi (1.7 bar)	#3	1.1	2.2	4.4	6.6	8.8	11	13.2	15.4	17.6	19.8	22	3.3	6.6	13.3	20	26.6	33.3	40	46.6	53.3	60	66.6
100MDC4	25 psi (1.7 bar)	#4	1.7	3.5	7	10.5	14	17.5	21	24.5	28	31.5	35	5.1	10.6	21.2	31.8	42.4	53	63.6	74.2	84.8	95.4	106
100MDC5	25 psi (1.7 bar)	#5	2.5	5	10	15	20	25	30	35	40	45	50	7.6	15.1	30.3	45.4	60.6	75.7	90.8	106	121.1	136.3	151.4

*Pump supplied with injection check valve for 25-100 psi (1.7-6.9 bar) applications

NOTICE: The information within this chart is solely intended for use as a guide. The output data is an approximation based on pumping water under a controlled testing environment. Many variables can affect the output of the pump. Stenner Pump Company recommends that all metering pumps undergo field calibration by means of analytical testing to confirm their outputs.

US and Canada 800.683.2378, International 904.641.1666

Outputs ' 70MDC series

Determining Output for Dual Head Dual Control Models

- The dial ring for adjustable pumps is marked L-10; L=5%, ' ' 0 indicates approximately 10% increments of maximum output.
- On the MDC models, the outer pump head operates on a percentage of the inner head (closest to the motor).
- Setting #10 on both pump heads will deliver the pump's maximum output and is the only time each pump head will output the same amount.

Example Using 170MDCHP34

- Decide on the desired output for the inner head.
- Note the setting on the dial ring that represents the desired output.
For example setting #8 = 80% of max output
In the 170MDCHP34 model, setting #8 = 13.6 gpd
- Repeat the above steps to calculate the output of the outer head.
Using setting #6 in this example,
#6 = 60% of the inner head output
 $13.6 \text{ gpd} \times 60\% = 8.2 \text{ gpd}$

In this example using pump model 170MDCHP34, the output for the inner head would be 13.6 gpd and 8.2 gpd for the outer head.

Outputs ' 70MDC series

Outputs for Innermost Head Only

Dual Head Dual Control	Maximum Pressure	Pump Tube Number	Approximate GPD @ 60Hz										Approximate LPD @ 50Hz											
			Feed Rate Control Setting																					
			L	1	2	3	4	5	6	7	8	9	10	L	1	2	3	4	5	6	7	8	9	10
170MDCHP9* 170MDC1	100 psi (6.9 bar) 25 psi (1.7 bar)	#1	0.3	0.5	1	1.5	2	2.5	3	3.5	4	4.5	5	0.9	1.5	3	4.5	6.1	7.6	9.1	10.6	12.1	13.6	15.1
170MDCHP34* 170MDC2	100 psi (6.9 bar) 25 psi (1.7 bar)	#2	0.8	1.7	3.4	5.1	6.8	8.5	10.2	11.9	13.6	15.3	17	2.4	5.1	10.3	15.4	20.6	25.7	30.9	36	41.2	46.3	51.5
170MDC3	25 psi (1.7 bar)	#3	2	4	8	12	16	20	24	28	32	36	40	6.1	12.1	24.2	36.3	48.5	60.6	76.7	84.8	96.9	109	121.1
170MDC4	25 psi (1.7 bar)	#4	3	6	12	18	24	30	36	42	48	54	60	9.1	18.2	36.3	54.5	76.7	90.8	109	127.2	145.3	163.5	181.7
170MDC5	25 psi (1.7 bar)	#5	4.3	8.5	17	25.5	34	42.5	51	59.5	68	76.5	85	13	25.7	51.5	77.2	103	128.7	154.4	180	205.9	231.6	257.4

*Pump supplied with injection check valve for 25-100 psi (1.7-6.9 bar) applications

NOTICE: The information within this chart is solely intended for use as a guide. The output data is an approximation based on pumping water under a controlled testing environment. Many variables can affect the output of the pump. Stenner Pump Company recommends that all metering pumps undergo field calibration by means of analytical testing to confirm their outputs.

US and Canada 800.683.2378, International 904.641.1666

Materials of Construction

All Housings*	Lexan® Polycarbonate Plastic
Peristaltic Tube**	Santoprene® FDA Approved
Check Valve Duckbill	
Peristaltic Tube†	Tygothane® FDA Approved
Check Valve Duckbill**	Pellathane®
Suction/Discharge Tubing	LDPE Polyethylene-NSF/FDA Approved
Ferrules (1/4" & 6 mm)	
Tube Fittings	Type 1 Rigid PVC-NSF Listed
Connecting Nuts	
Check Valve Fittings	
Weighted Suction Line Strainer	
All Fasteners	Stainless Steel

*Lexan® is a registered trademark of General Electric. Consult General Electric for chemical resistance of Lexan®.

**Santoprene® is a registered trademark of Advanced Elastomer System.

†Tygothane® is a registered trademark of Saint-Gobain Performance Plastics.

**Pellathane® is a registered trademark of The Dow Company.

Accessory Checklist – pre-installation

25 psi Accessory Kit Contents*

- 3 Connecting Nuts 1/4" or 3/8"
- 3 Ferrules 1/4" & 6 mm *Europe*
OR 2 Ferrules 3/8"
- 1 Injection Fitting
- 1 Weighted Suction Line Strainer 1/4", 3/8", 6 mm *Europe*
- 1 20' Roll of Suction/Discharge Tubing
1/4" or 3/8" White or UV Black
OR 6 mm White *Europe*
- 1 Spare Pump Tube
- 1 Mounting Bracket
- 1 Installation Manual

100 psi Accessory Kit Contents*

- 3 Connecting Nuts 1/4" or 3/8"
- 3 Ferrules 1/4" & 6 mm *Europe*
OR 2 Ferrules 3/8"
- 1 Injection Check Valve
- 1 Weighted Suction Line Strainer 1/4" or 3/8", 6 mm *Europe*
- 1 20' Roll of Suction/Discharge Tubing
1/4" or 3/8" White or UV Black
OR 6 mm White *Europe*
- 1 Spare Pump Tube
- 1 Mounting Bracket
- 1 Installation Manual

* Double head pumps include an additional set of the accessories listed above.

US and Canada 800.683.2378, International 904.641.1666

17

Installation – additional safety instructions

! NOTICE: Indicates special instructions or general mandatory action.

- !** Read all safety hazards before installing or servicing the pump. The pump is designed for installation and service by properly trained personnel.
- !** Use all required personal protective equipment when working on or near a chemical metering pump.
- !** Install the pump so that it is in compliance with all national and local plumbing and electrical codes.
- !** Use the proper product to treat potable water systems, use only chemicals listed or approved for use.
- !** Install the pump to work in conjunction with pool, spa, well pump, or system controls.

Installation continued – mount pump

MOUNT PUMP

! Select a dry location (to avoid water intrusion and pump damage) above the solution tank. Best recommended location is above the solution tank in a vertical position with the pump head pointed downward and the spill recovery (see next page) in place to reduce the risk and severity of damage.

! To prevent pump damage in the event of a pump tube leak, never mount the pump vertically with the pump head up.

! To avoid chemical damage from fumes, DO NOT mount pump directly over an open solution tank. Keep tank covered.

! Avoid flooded suction or pump mounted lower than the solution container. Draw solution from the top of the tank. Pump can run dry without damage. If pump is installed with a flooded suction, a shut-off valve or other device must be provided to stop flow to pump during service.

1. Use the mounting bracket as a template to drill pilot holes in mounting location.

2. Secure bracket with fasteners or wall anchors. Slide pump into bracket.

! Provide 8" clearance to allow pump orientation to be reversed during tube replacement. DO NOT allow water intrusion into the motor or corrosion and damage will occur.

! To prevent motor damage, verify with a volt meter that the receptacle voltage corresponds with the pump voltage.

3. Plug cord into receptacle and turn the motor power switch on. If the pump is adjustable, turn the dial ring to 10.

4. Activate the pump by the pump control (flow switch, pressure switch, etc.) and verify rotation of the roller assembly within the clear pump head. Turn pump switch off.

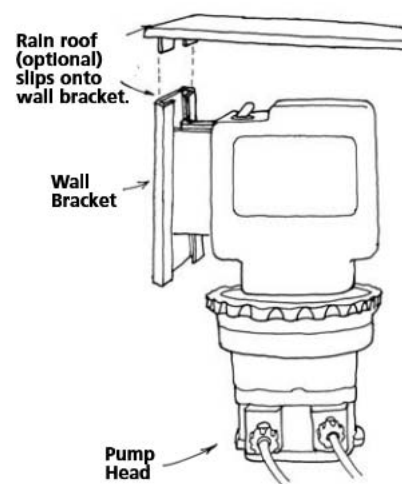

US and Canada 800.683.2378, International 904.641.1666

Installation continued – additional instructions for CE pumps

Additional Installation Instructions

1. All Class II Pumps located in Zone 1 of swimming pool areas require locating where flooding cannot occur.
2. This pump is intended to be installed as "fixed" as opposed to portable.
3. The Rain Roof must be installed and "vertical orientation" mounting of entire unit observed.
4. After installation, the power supply plug must be accessible during use.
5. This unit must be scrapped if the supply cord is damaged.
6. Observe and comply with all National Wiring Standards.

Zusätzliche Installierungsanweisung un

1. Pumpen die sich in Zone 1 vom Schwimmbecken befinden sollen sind so einzurichten daß Ueberschwemmungen nicht vorkommen werden.
2. Diese Pumpe ist als fest montierte Ausrüstung bedacht und soll nicht umstellbar gebraucht werden.
3. Der Regendach muss installiert werden. Eine vertikale Asrichtung der Montage muß erzielt werden.
4. Die Stromversorgung muss nach der Installierung noch zugänglich sein.
5. Bei beschadigter Verkabelung ist dieses Gerät nicht mehr zu gebrauchen.
6. Staatliche Vernetzungsvorchriften müssen eingehalten werden.

Instructions Supplémentaires d'Installation

1. Toutes les pompes installées dans la Zone 1 du périmètre de la piscine doivent être situées de manière à ne pas pouvoir être inondées.
2. Cette pompe est prévue pour installation fixe et non pas portative.
3. L'abri anti-pluie doit être installé et l'orientation verticale doit toujours être observée.
4. Après l'installation, la prise électrique doit rester accessible pendant l'utilisation.
5. Cette unité doit être mise au rebut si le cordon électrique est endommagé.
6. Observez et adhérez à toutes les Normes Nationales pour Installations Electriques.

Instucciones Adicionales Para instalación

1. Todas las bombas Clase II situadas en la Zona 1 de las áreas de la piscina requieren colocarse donde no puedan ser inundadas.
2. Esta bomba es para ser instalada "fija" en vez de portátil.
3. Es necesario instalar el techo de lluvia, y montar la unidad entera siguiendo una orientación vertical.
4. Después de la instalación el enchufe suministrador de energía debe estar accesible durante el uso.
5. Se deberá deshechar la unidad si el cordón de abastecimiento se deteriora.
6. Observe y cumpla con todas las Reglas Nacionales para Instalaciones Eléctricas.

Istruzioni Supplementari Per L'installazione

1. Tutte le pompe Classe II localizzate nella Zona 1 della superficie circostante la piscina devono essere collocate dove gli allagamenti non possono accadere.
2. Questa pompa, è inteso, deve essere installata come 'fissa' e non come portatile.
3. La tettoia deve essere installata e il montaggio 'orientazione verticale' dell'intera unità deve essere osservato.
4. Dopo l'installazione, la spina deve essere accessibile durante l'uso.
5. Questa unità deve essere gettata via se il filo elettrico è danneggiato.
6. Osservare e aderire a tutte le Norme Nazionali Sugli Impianti Elettrici.

Installation Diagram

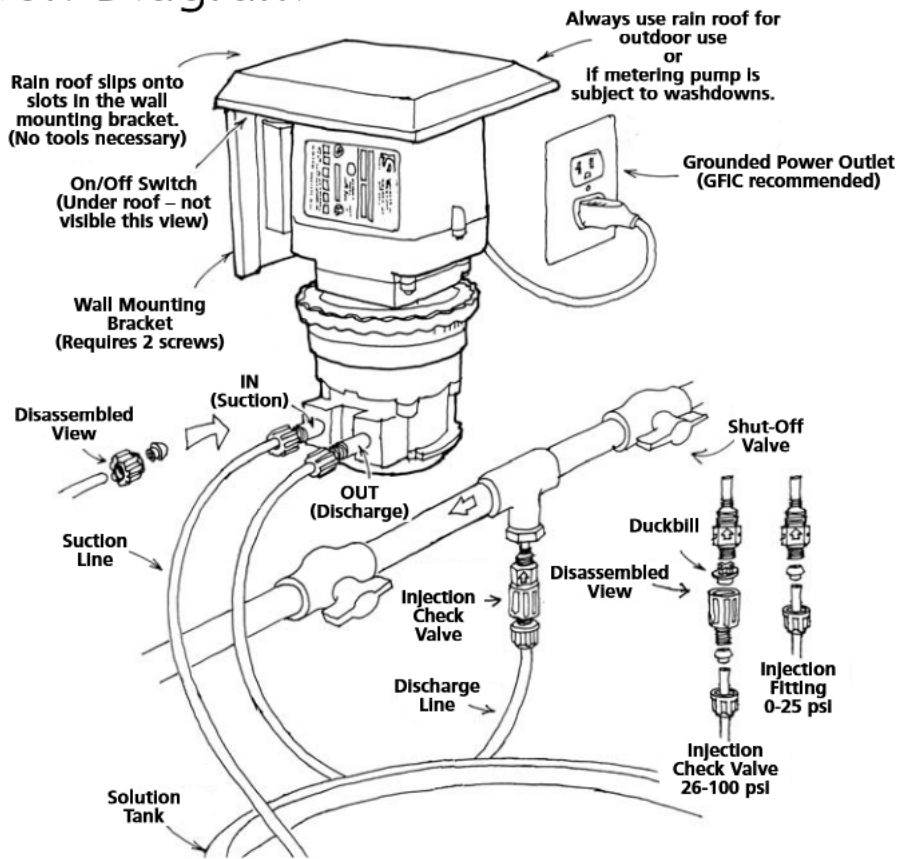

US and Canada 800.683.2378, International 904.641.1666

Installation continued – spill recovery

SPILL RECOVERY

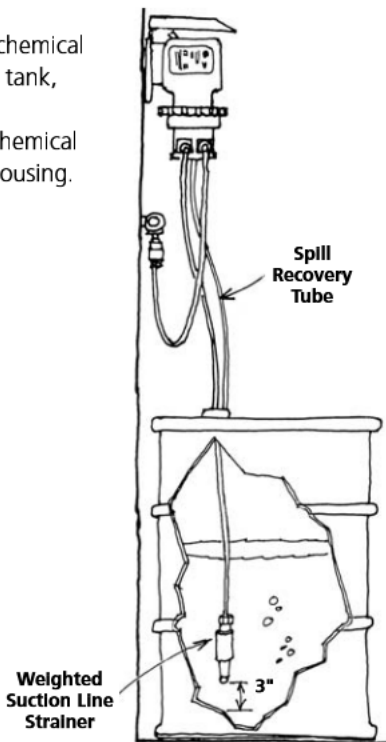
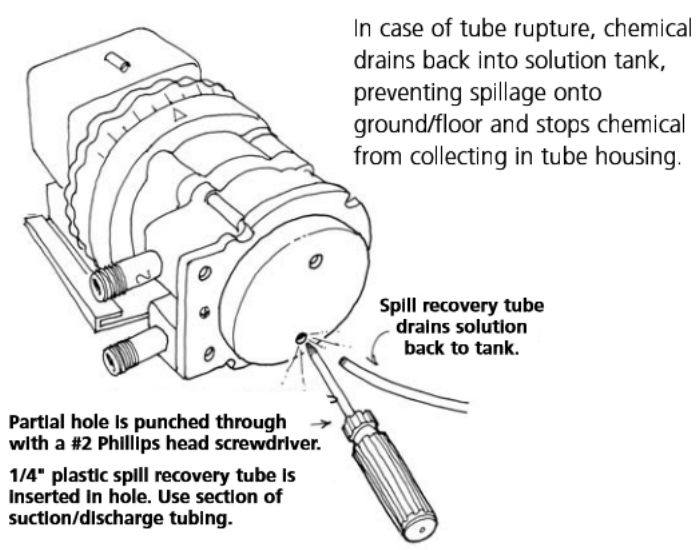

Installation continued – suction/discharge lines

INSTALL SUCTION/DISCHARGE LINE TO PUMP HEAD

1. Uncoil the suction/discharge line. Use outside of solution tank as a guide to cut proper length of suction line ensuring it will be 2-3' above the bottom of solution tank.

! Allow sufficient slack to avoid kinks and stress cracks. Always make a clean square cut to assure that the suction line is burr free. Normal maintenance requires trimming.

! Suction lines that extend to the bottom of the tank can result in debris pickup leading to clogged injectors and possible tube failure.

2. Make connections by sliding the line(s) through connecting nut* and ferrule and finger tighten to the corresponding tube fittings. Suction side tube connection is indicated by "IN" on the tube housing cover.

3. Finger tighten nut to the threaded tube fitting while holding the tube fitting.

! Over tightening the ferrule and nut with a wrench may result in damaged fittings, crushed ferrules, and air pick up.

! DO NOT use thread sealant tape on pump tube connections or tools to tighten connections.

DO NOT use thread sealant tape on pump tube threads.

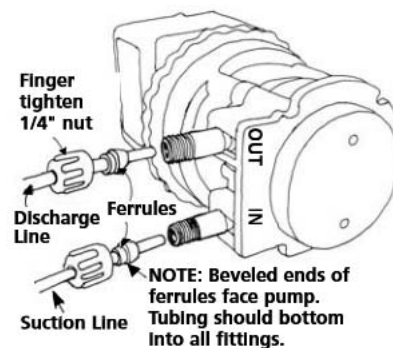
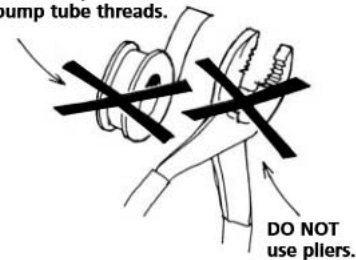

More on next page...

* For 3/8" connections only. While stabilizing the tube fitting, attach female end of adapter to the tube fitting(s) (ferrule inside). Slide line through 3/8" connecting nut and finger tighten to male end of adapter. If leak occurs, gradually tighten the 3/8" connecting nut as required.

US and Canada 800.683.2378, International 904.641.1666

23

Installation continued – suction line

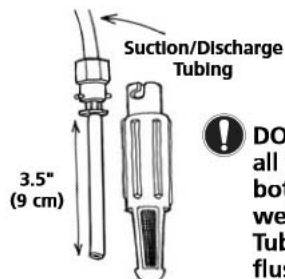
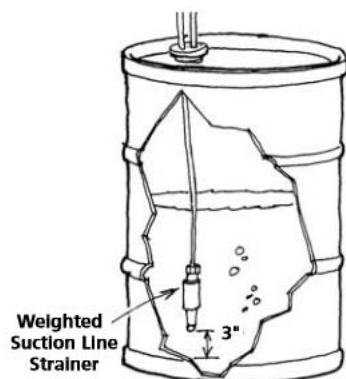

! DO NOT slide tubing all the way to the bottom of the weighted strainer. Tubing could become flush with the nose of the strainer and the pump may not prime due to blockage.

INSTALL SUCTION WEIGHT

1. Drill a hole into the bung cap or solution tank lid. Slide the tubing through and secure the weighted strainer to the line.
 2. To attach the strainer, slide approximately 3 1/2' of tubing through the collet and lock into place on strainer body. Pull tubing to make sure it is secure.
 3. Suspend slightly above tank bottom to reduce the chance of sediment pickup.
- !** DO NOT mix chemicals in the solution container. Follow recommended mixing procedures according to the manufacturer.
- !** DO NOT operate pump unless chemical is completely in solution. Turn pump off when replenishing solution.

Installation continued – point of injection

INSTALL INJECTION POINT

1. Make a secure finger tight connection on the discharge fitting of the pump head as instructed in Install Suction Line instructions.

! **DO NOT use thread sealant tape on pump tube connections or tools to tighten connections.**

⚠ WARNING

HAZARDOUS PRESSURE: Shut off water or circulation system and bleed off any system pressure.

! **Locate a point of injection beyond all pumps and filters or as determined by the application.**

2. A 1/4" or 1/2" Female NPT (FNPT) connection is required for installing the injection fitting. If there is no FNPT fitting available, provide one by either tapping the pipe or installing FNPT pipe tee fitting.
3. Wrap the Male NPT (MNPT) end of injection fitting with 2 or 3 turns of threading tape. If necessary, trim the injection fitting quill as required to inject product directly into flow of water.

DO NOT use thread sealant tape on pump tube threads.

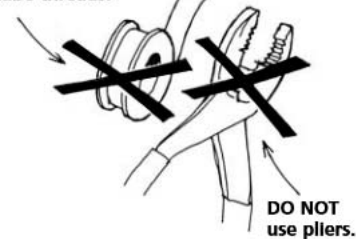

More on next page...

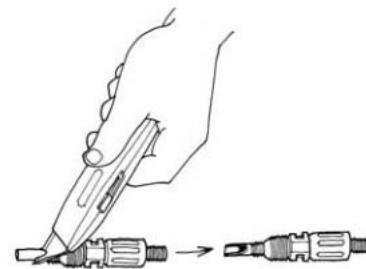

Trim Injection Fitting

US and Canada 800.683.2378, International 904.641.1666

25

Installation continued – point of injection

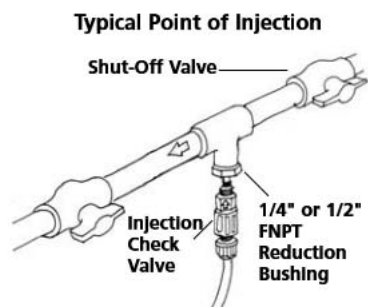

⚠ WARNING

HAZARDOUS PRESSURE:
Shut off water or circulation system and bleed off any system pressure.

4. Hand tighten the injection fitting into the FNPT fitting.

**0-25 psi Models
(includes injection fitting)**

- a. Install connecting nut* and ferrule to the pump discharge tubing. Insert discharge tubing into injection fitting until it reaches base of fitting.
- b. Finger tighten connecting nut* to fitting.

**26-100 psi Models
(includes injection check valve)**

- a. Prior to connection, test injection check valve and NPT threads for leaks by pressurizing system. If necessary, tighten an additional 1/4 turn.
- b. Install connecting nut* and ferrule to the pump discharge tubing. Insert discharge tubing into check valve body until it reaches base of body.
- c. Finger tighten connecting nut* to fitting.

5. Turn pump on and re-pressurize system. Observe chemical flow as actuated by system and check all connections for leaks.
6. After suitable amount of dosing time, perform tests for desired chemical readings (e.g., pH or ppm). If necessary, fine tune dosing levels by rotating dial ring (adjustable pumps only) or by adjusting solution strength.

⚠ The injection point and fitting require periodic maintenance to clean any deposits or buildup. To allow quick access to the point of injection, Stenner recommends the installation of shut-off valves.

* For 3/8" connections, insert discharge tubing until it reaches base of injection fitting (25 psi) or check valve body (100 psi). If leak occurs, gradually tighten the 3/8" connecting nut as required.

www.stenner.com

Troubleshooting – motor

PROBLEM	POSSIBLE CAUSE	SOLUTION
 WARNING HAZARDOUS VOLTAGE: DISCONNECT power cord before removing motor cover for service. Electrical service should be by trained personnel only.		
Loud or excessive noise	Worn ball bearings Insufficient lubrication Worn gears or gear posts	Replace rotor assembly AquaShield® grease to gears and gear posts Inspect and/or replace gears and gear posts
Motor does not work; fan does not turn	Faulty electrical supply Rotor bound to coil Damaged motor coil Worn or damaged motor bearings Damaged power cord Rotor rusted to coil Faulty wire connections Obstructed fan	Check supply voltage circuit Replace bearing brackets if cracked Replace motor coil Replace rotor assembly Inspect and/or replace power cord Clean off coil and motor or replace Inspect and/or repair electrical connections Remove obstruction
Motor runs; fan turns; output shaft does not	Check all gears	Replace gears as needed
Motor overheats and shuts off and on	Incorrect voltage High ambient temperature Damaged/malfunctioning coil	Check voltage and frequency matches data label Pumps are rated at 125°F maximum Replace motor coil
Phenolic gear is stripping	Water intrusion Cracked bearing bracket Worn gear posts Rusted helical gear at end of rotor Worn gear case cover Insufficient lubrication	Use rain roof Replace bearing bracket Replace gear posts Buff off rotor or replace rotor Replace gear case Lubricate with AquaShield®

US and Canada 800.683.2378, International 904.641.1666

Troubleshooting continued – feed rate control

PROBLEM	POSSIBLE CAUSE	SOLUTION
Adjustment ring will not turn	Seized variable cam Seized adjustment ring	Grease variable cam & cam slot Clean then lubricate ring with AquaShield®
Adjustment ring turns, output doesn't change	Variable cam disengaged from ring Broken variable cam	Re-insert 90° end into ring Replace variable cam
Pump head does not rotate	Worn index plate Motor problem Pump head roller assembly stripped Index pin holder loose Index pin broken	Turn over or replace index plate Refer to Motor section Replace roller assembly Tighten holder into spider assembly Replace index pin and lifter assembly
Pump head rotates continuously	Variable cam	Replace or re-insert variable cam
Erratic indexing	Index plate worn Variable cam worn Lifter worn	Turn over or replace index plate Replace variable cam Replace index pin & lifter assembly

Troubleshooting continued – pump head

PROBLEM	POSSIBLE CAUSE	SOLUTION
Components cracking	Chemical attack	Check chemical compatibility
Pump head leaking	Pump tube rupture	Replace pump tube, ferrules; center tube
No pump output, pump head rotates	Depleted solution tank Pump suction line weight is above solution Leak in the suction line Ferrules installed incorrectly, missing or damaged Injection point is clogged Clogged suction/discharge tubing and/or injection check valve Life of pump tube exhausted Suction tubing is flush with the nose of the weighted strainer	Replenish solution Replenish solution Inspect or replace suction line Replace ferrules Inspect and clean injection point Clean and/or replace as needed Replace pump tube, ferrules; center tube Pull suction tubing approximately 1' from bottom of strainer Cut bottom of suction tubing at an angle
Low pump output, pump head rotates	Life of pump tube exhausted Rollers worn or broken Injection point is restricted Incorrect tube size High system back pressure	Replace pump tube, ferrules; center tube Replace roller assembly Inspect and clean injection point Replace tube with correct size Verify system pressure against tube psi, replace tube if needed
No pump output; pump head doesn't rotate	Stripped roller assembly Feed rate control problem Motor problem	Replace roller assembly Refer to feed rate control section Refer to motor section
Pump output high	Incorrect tube size or setting Roller assembly broken Malfunctioning feed rate control Incorrect motor rpm	Replace tube with correct size or adjust settings. Replace roller assembly Refer to feed rate control section Replace with motor that matches pump model





US and Canada 800.683.2378, International 904.641.1666

Troubleshooting continued – pump tube

PROBLEM	POSSIBLE CAUSE	SOLUTION
<p>NOTICE: A leaking pump tube damages the metering pump. Inspect pump frequently for leakage and wear. Refer to Tube Replacement section for additional safety precautions and instructions.</p>		
Tube leaking	<ul style="list-style-type: none"> Pump tube ruptured Calcium or mineral deposits Excessive back pressure Tube is twisted Tube not centered 	<ul style="list-style-type: none"> Replace pump tube, ferrules; center tube Clean injection fitting, replace pump tube, ferrules; center tube Verify system pressure against tube psi, replace tube if needed Replace pump tube, ferrules; center tube Replace pump tube, ferrules; center tube
Tube life is shortened	<ul style="list-style-type: none"> Chemical attack Mineral deposits at injection point Sediment blockage at check valve Degraded check valve duckbill Duckbill in wrong orientation Tube manually stretched or pinched during replacement Seized rollers caused abrasion on tube Exposure to heat or sun 	<ul style="list-style-type: none"> Check chemical compatibility Remove deposits, replace pump tube, ferrules; center tube Maintain suction line 2-3' above bottom of tank Replace duckbill at every tube change Reverse duckbill orientation Follow tube replacement instructions and allow roller assembly to stretch tube into place Clean roller assembly or replace Do not store tubes in high temperatures or in direct sunlight
Tube connection is leaking	<ul style="list-style-type: none"> Missing ferrule on 1/4' line Crushed ferrule Ferrule in wrong orientation 3/8' nut loose Missing ferrule in 3/8' adapter 	<ul style="list-style-type: none"> Replace ferrule Replace ferrule Reverse orientation of ferrule Secure adapter and tighten 3/8' nut as needed Replace with new adapter fitting or insert new ferrule into adapter

Tube Replacement – safety information



WARNING RISK OF CHEMICAL EXPOSURE:

-  To reduce risk of exposure, check the pump tube regularly for leakage. At the first sign of leakage, replace the pump tube.
-  To reduce risk of exposure, the use of proper personal protective equipment is mandatory when working on or near chemical metering pumps.
-  To reduce risk of exposure, and also prior to service, shipping, or storage, pump generous amounts of water or a compatible buffer solution to remove chemical from pump.
-  Consult chemical manufacturer and MSDS sheet for additional information and precautions for the chemical in use.
-  Personnel should be skilled and trained in the proper safety and handling of the chemicals in use.





CAUTION PINCH POINT HAZARD:

-  Use extreme caution when replacing pump tube. Be careful of your fingers and **DO NOT** place fingers near rollers.

WARNING HAZARDOUS PRESSURE/CHEMICAL EXPOSURE:

-  Use caution and bleed off all resident system pressure prior to attempting service or installation.
-  Use caution when disconnecting discharge tubing from pump. Discharge may be under pressure. Tubing may contain chemical.

NOTICE: Indicates special instructions or general mandatory action.

-  **NOTICE: DO NOT** apply grease, oil, or lubricants to the pump tube or housing.
-  **NOTICE:** Prior to pump tube replacement, inspect the entire pump head for cracks or damaged components. Ensure rollers turn freely.
-  **NOTICE:** Rinse off chemical residual and clean all chemical and debris from pump head components prior to tube replacement. Apply Stenner grease to main shaft and tube housing cover bushing during tube replacement.
-  **NOTICE: DO NOT** pull excessively on pump tube. Avoid kinks or damage during tube installation.
-  **NOTICE:** Inspect the suction/discharge tubing, injection point (into pipe), and injection check valve duckbill for blockages after any tube rupture. Clear or replace as required.

US and Canada 800.683.2378, International 904.641.1666

31

Tube Replacement continued – preparation

1. Follow all safety precautions prior to tube replacement.
2. Prior to service, pump water or a compatible buffer solution through the pump and suction/discharge line to remove chemical and avoid contact.
3. Turn pump off.
4. Disconnect the suction and discharge connections from pump head.
5. Plug power cord into constantly energized, properly grounded receptacle for service.

Tube Replacement continued – remove old tube

REMOVE OLD TUBE

1. Remove and set aside cover and screws.
2. Set feed rate dial on the low setting until finished.
3. Turn pump on and let it run until one of three roller assembly slots lines up with the tube fitting on the suction side.
Illustration A
4. Turn pump off.
5. Lift tube fitting out of housing slot and pull it toward center of roller assembly.
Illustration B
6. Turn pump on and allow roller assembly to jog while guiding tube, with tension, up and out of housing. **Illustration C**
7. Turn pump off. Remove and discard pump tube.
8. Remove roller assembly, shaft, and housing.
9. Use non-citrus all-purpose cleaner to clean chemical residue from pump head housing, roller, and cover.
10. Check housing for cracks. Replace if cracked.
11. Ensure rollers spin freely. **Illustration D**
12. Replace roller assembly if: seized, excessive side play from bore wear, or if rollers are visibly worn.
13. Reinstall clean tube housing.
14. Grease shaft tip and install.
15. Install roller assembly.

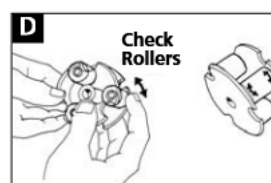
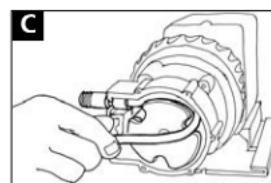
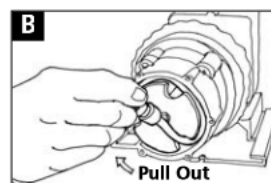
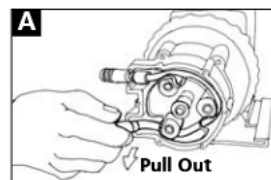

US and Canada 800.683.2378, International 904.641.1666

Tube Replacement continued – install new tube

IMPORTANT! DO NOT lubricate pump tube or roller assembly.

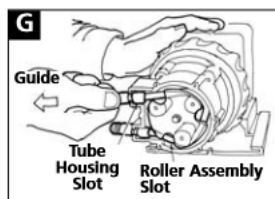
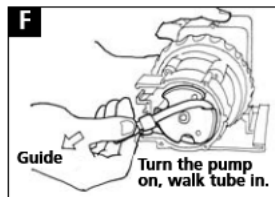
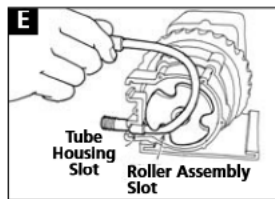

NOTE: Cover screws are self-tapping and must be backed in to locate original thread before securing. If a screw boss is stripped, use alternate bosses and position opposite from each other. Never secure the cover plate with more than 2 screws.

34

INSTALL NEW TUBE

1. Manually rotate the roller assembly counter clockwise to align one of three roller assembly slots with the suction side housing slot.
2. Place tube fitting into suction side slot of the housing and the roller assembly slot.

Illustration E

3. With pump setting on low, hold tube fitting and jog roller assembly by turning pump on.

IMPORTANT! Avoid rotating wrist, which can result in a twisted tube that will not center. **DO NOT** force tube and be careful of your fingers.

4. Guide tube, with slight tension (toward the center) to prevent pinching between housing and roller assembly. **Illustration F**

5. When tube reaches the top housing slot, turn pump off.
6. Turn dial ring to setting 10, hold tube fitting firmly, and turn pump on.

NOTE: A used tube will have stretched approximately 3/4' and the new tube will appear to be stiff and short. Follow directions to allow rollers to stretch tube into place.

7. Allow rollers to stretch tube into place while guiding tube into slot. **Illustration G**
8. Turn pump off.
9. Apply a small amount of grease (AquaShield®) to cover bushing ONLY and replace cover and two screws, leaving front screw in-between the fittings loose.

www.stenner.com

Tube Replacement continued – center new tube

CENTER NEW TUBE

1. To center pump tube on rollers, set feed rate dial to setting '0'. Turn pump on.
Illustration H
2. Turn the tube fitting on the suction side not more than 1/8 of a turn in the direction tube must move.
3. **DO NOT** let go of fitting until tube rides approximately in center of rollers.
4. Turn pump off, let go of fitting, and tighten cover screws. Cover is not on securely if there is a gap between screw boss and cover.

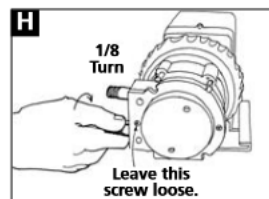

TUBE CHANGE FOR FIXED OUTPUT PUMP

1. To install a new tube in a fixed output pump, follow the instructions above and utilize the on/off switch to jog the roller assembly in the absence of the feed rate control. **Illustration I**

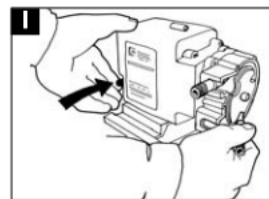

US and Canada 800.683.2378, International 904.641.1666

35

Motor – exploded view

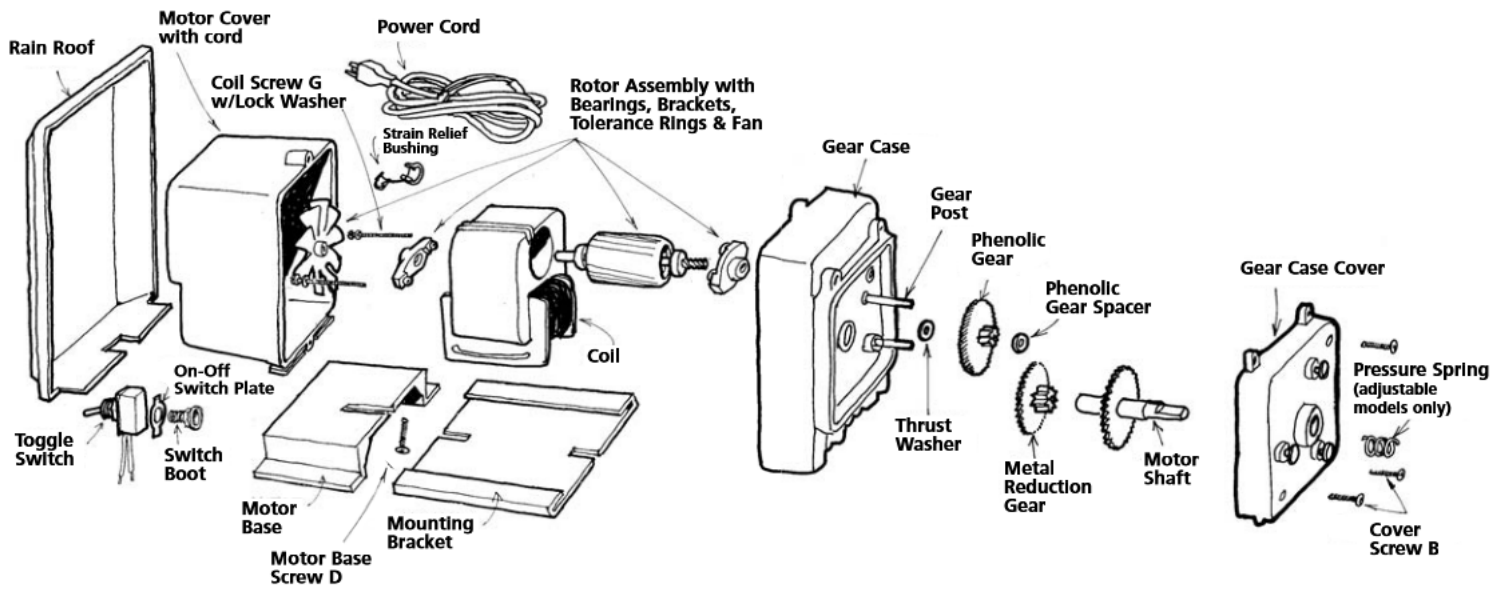

Motor continued – subassemblies

MOTORS

DESCRIPTION	PART NUMBER	UM	PART NUMBER	UM
Motor 60Hz Adjustable output 45 & 100 series	(120V) PM6041D	EA	(220V) PM6042D	EA
Motor 60Hz Adjustable output 85 & 170 series	(120V) PM6081D	EA	(220V) PM6082D	EA
Motor 60Hz Fixed output 45MP series	(120V) ME6041D	EA	(220V) ME6042D	EA
Motor 60Hz Fixed output 85MP series	(120V) ME6081D	EA	(220V) ME6082D	EA
Motor 60Hz Fixed output 100DMP series	(120V) DM6041D	EA	(220V) DM6042D	EA
Motor 60Hz Fixed output 170DMP series	(120V) DM6081D	EA	(220V) DM6082D	EA

INTERNATIONAL

Motor 50Hz Adjustable output 45 & 100 series	(230V) PM64230	EA	(250V) PM6426D	EA
Motor 50Hz Adjustable output 85 & 170 series	(230V) PM68230	EA	(250V) PM6826D	EA
Motor 50Hz Fixed output 45MP series	(230V) ME64230	EA	(250V) ME6426D	EA
Motor 50Hz Fixed output 85MP series	(230V) ME68230	EA	(250V) ME6826D	EA
Motor 50Hz Fixed output 100DMP series	(230V) DM64230	EA	(250V) DM64250	EA
Motor 50Hz Fixed output 170DMP series	(230V) DM68230	EA	(250V) DM68250	EA

Motor Subassembly

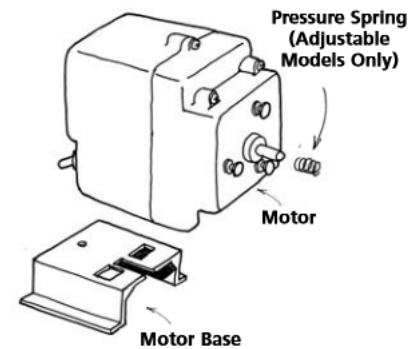

US and Canada 800.683.2378, International 904.641.1666

Motor continued – service kits

Motor Service Kit

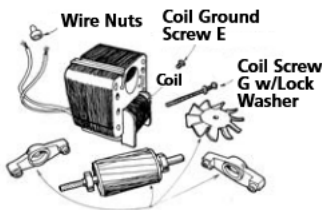

Rotor Assembly with Bearings, Brackets, Tolerance Rings & Fan

MOTOR SERVICE KITS

DESCRIPTION	PART NUMBER	UM	PART NUMBER	UM
Motor Service Kit 60Hz	(120V) MSK120	KIT	(220V) MSK220	KIT

Gear Case Service Kit

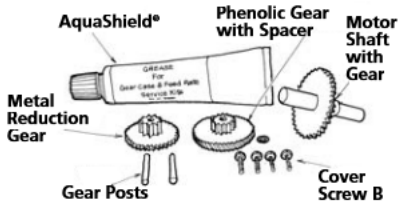

GEAR CASE SERVICE KITS

DESCRIPTION	PART NUMBER	UM
Gear Case Service Kit Adjustable output 45 & 100 series	GSK45A	KIT
Gear Case Service Kit Adjustable output 85 & 170 series	GSK85A	KIT
Gear Case Service Kit Fixed output 45MP series	GSK45F	KIT
Gear Case Service Kit Fixed output 85MP series	GSK85F	KIT

Feed Rate Control – exploded view

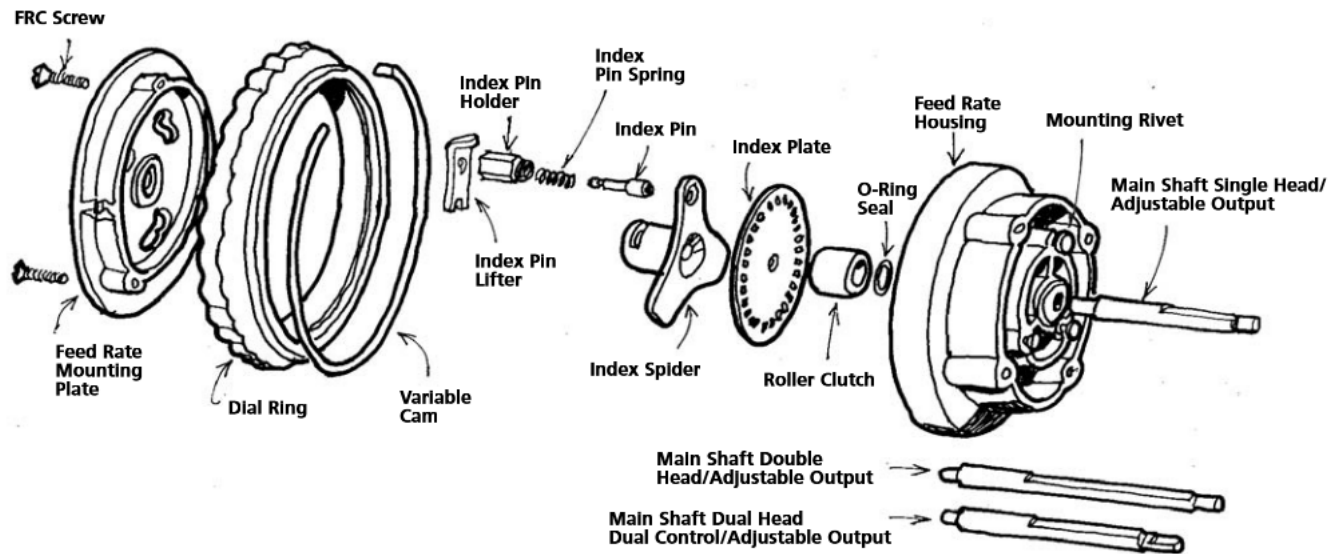

Contact factory for part numbers.

US and Canada 800.683.2378, International 904.641.1666

Feed Rate Control continued – subassemblies & service kits

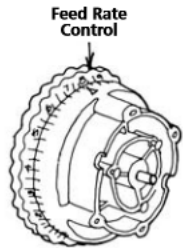

FEED RATE CONTROLS

DESCRIPTION	PART NUMBER	UM
Feed Rate Control with shaft Single head 45 & 85 adjustable series	FC5040D	EA
Feed Rate Control with shaft Double head 100 & 170 adjustable series	DM5040D	EA
Feed Rate Control with shaft Dual head dual control 100MDC & 170MDC series	DM504DC	EA

FEED RATE CONTROL SERVICE KIT

DESCRIPTION	PART NUMBER	UM
Feed Rate Control Service Kit	FSK100	KIT

Feed Rate Control Service Kit

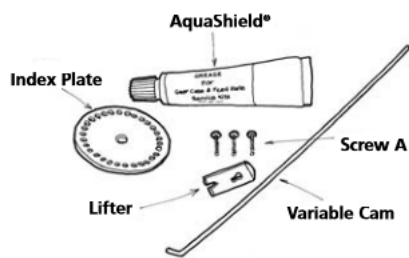

Pump Head – exploded view

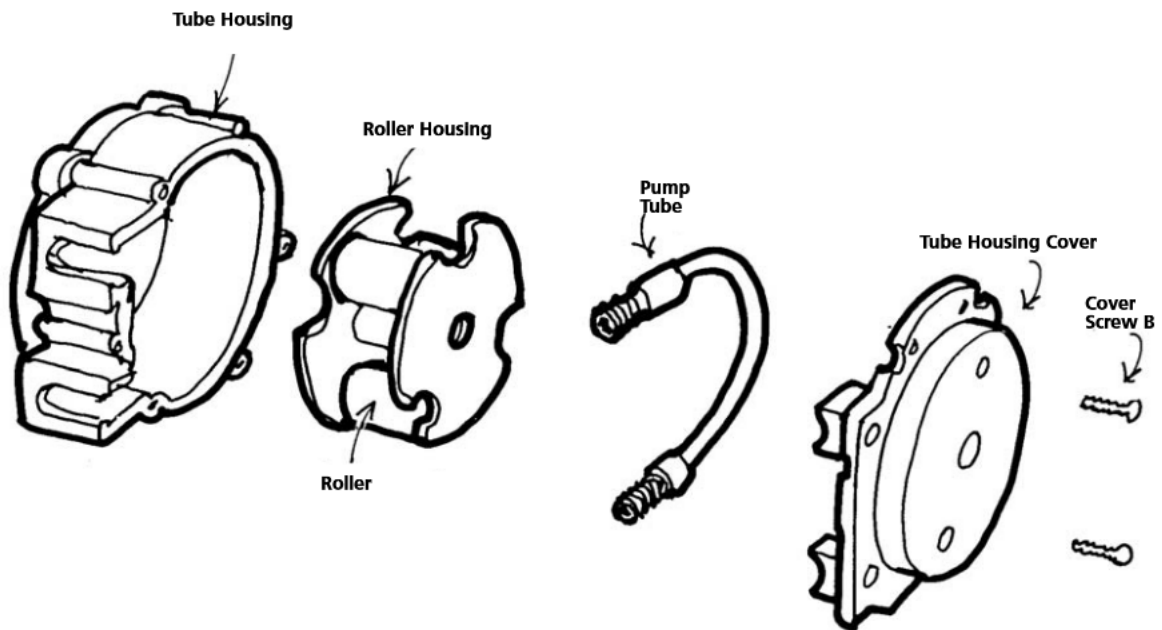

Contact factory for part numbers.

US and Canada 800.683.2378, International 904.641.1666

Pump Head continued – subassemblies

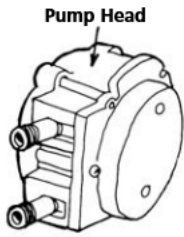

PUMP HEADS

DESCRIPTION	PART NUMBER	UM	PART NUMBER	UM
Pump Head includes SANTOPRENE® pump tube, ferrules 1/4'	UCTHC_*_D	EA	MCTHC_*_D	PK of 2
	* select tube number 1, 2, 3, 4, 5, 7			
Pump Head includes SANTOPRENE® pump tube & duckbill, ferrules 1/4'	UCPH_*_FD	EA	n/a	
	* select tube number 1, 2, 7			
Pump Head includes TYGOTHANE® pump tube, ferrules 1/4'	UCPHT0_*	EA	n/a	
	* select tube number 2, 5			
Pump Head includes TYGOTHANE® #2 pump tube, PELLATHANE® duckbill, ferrules 1/4'	UCPHTD2	EA	n/a	

EUROPE

Pump Head includes SANTOPRENE® pump tube, ferrules 6 mm	UCTH_*_CE	EA	MCTH_*_CE	PK of 2
	* select tube number 1, 2, 3, 4, 5, 7			
Pump Head includes SANTOPRENE® pump tube & duckbill, ferrules 6 mm	UCPH_*_CE	EA	n/a	
	* select tube number 1, 2, 7			
Pump Head includes TYGOTHANE® pump tube, ferrules 6 mm	UCPHT_*_CE	EA	n/a	
	* select tube number 2, 5			
Pump Head includes TYGOTHANE® #2 pump tube, PELLATHANE® duckbill, ferrules 6 mm	UCPHD2CE	EA	n/a	

Pump Tube Numbers

#1 and #2 for 26-100 psi pump (when used with check valve).

#1, 2, 3, 4, 5 for 0-25 psi pump.

#7 tube for 26-100 psi single head pump only.

Pump Head continued – service kits

PUMP HEAD SERVICE KITS

DESCRIPTION	PART NUMBER	UM
SANTOPRENE® Kit 0-25 psi (0-1.7 bar)	PSKLO * * select tube number 1, 2, 3, 4, 5	KIT
SANTOPRENE® Kit 26-100 psi (1.7-6.9 bar)	PSKH0 * * select tube number 1, 2, 7	KIT
TYGOTHANE® Kit 0-25 psi (0-1.7 bar)	PSKLT * * select tube number 2 or 5	KIT
Kit 26-100 psi (1.7-6.9 bar) includes TYGOTHANE® #2 Pump Tube & PELLATHANE® duckbill	PSKHT2	KIT
EUROPE		
SANTOPRENE® Kit 0-1.7 bar	PSKL * CE * select tube number 1, 2, 3, 4, 5	KIT
SANTOPRENE® Kit 1.7-6.9 bar	PSKH * CE * select tube number 1, 2, 7	KIT
TYGOTHANE® Kit 0-1.7 bar	PSKLT * CE * select tube number 2 or 5	KIT
Kit 1.7-6.9 bar includes TYGOTHANE® #2 Pump Tube & PELLATHANE® duckbill	PSKHT2CE	KIT

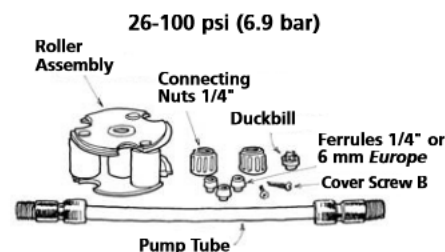
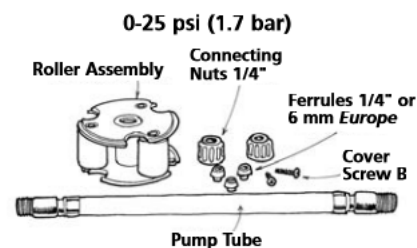

US and Canada 800.683.2378, International 904.641.1666

Adapter Pump Heads – subassemblies

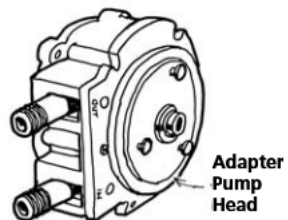

ADAPTER PUMP HEADS

DESCRIPTION	PART NUMBER	UM	PART NUMBER	UM
Adapter Pump Head includes SANTOPRENE® pump tube, ferrules 1/4'	UC1ATC_*	EA	MC1ATC_*	PK of 2
	* select tube number 1, 2, 3, 4, 5			
Adapter Pump Head includes SANTOPRENE® pump tube & duckbill, ferrules 1/4'	UCAH_*_FD	EA		n/a
	* select tube number 1, 2			
Adapter Pump Head includes TYGOTHANE® pump tube, ferrules 1/4'	UCAHT0_*	EA		n/a
	* select tube number 2, 5			
Adapter Pump Head includes #2 TYGOTHANE® pump tube PELLATHANE® duckbill, ferrules 1/4'	UCAHTD2	EA		n/a

EUROPE

Adapter Pump Head includes SANTOPRENE® pump tube, ferrules 6 mm	UCAP_*_CE	EA	MCAP_*_CE	PK of 2
	* select tube number 1, 2, 3, 4, 5			
Adapter Pump Head includes SANTOPRENE® pump tube & duckbill, ferrules 6 mm	UCAH_*_CE	EA		n/a
	* select tube number 1, 2			
Adapter Pump Head includes TYGOTHANE® pump tube, ferrules 6 mm	UCAT_*_CE	EA		n/a
	* select tube number 2, 5			
Adapter Pump Head includes #2 TYGOTHANE® pump tube, PELLATHANE® duckbill, ferrules 6 mm	UCT2DCE	EA		n/a

Pump Tubes

PUMP TUBES

DESCRIPTION	PART NUMBER	UM	PART NUMBER	UM
SANTOPRENE® Pump Tube ferrules 1/4'	UCCP20 *	PK of 2	MCCP20 *	PK of 5
	* select tube number 1, 2, 3, 4, 5, 7			
SANTOPRENE® Pump Tube & Duckbill, ferrules 1/4'	UCCP * FD	PK of 2	n/a	
	* select tube number 1, 2, 7			
TYGOTHANE® Pump Tube, ferrules 1/4'	UCTYG0 *	PK of 2	MCTYG0 *	PK of 5
	* select tube number 2, 5			
TYGOTHANE® #2 Pump Tube & PELLATHANE® Duckbill, ferrules 1/4'	UCTY2FD	PK of 2	n/a	

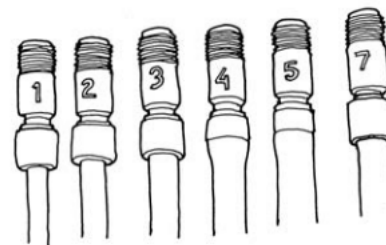

EUROPE

SANTOPRENE® Pump Tube ferrules 6 mm	UCCP2 * CE	PK of 2	MCCP2 * CE	PK of 5
	* select tube number 1, 2, 3, 4, 5, 7			
SANTOPRENE® Pump Tube & Duckbill, ferrules 6 mm	UC * FDCE	PK of 2	n/a	
	* select tube number 1, 2, 7			
TYGOTHANE® Pump Tube ferrules 6 mm	UCTY * CE	PK of 2	MCTY * CE	PK of 5
	* select tube number 2, 5			
TYGOTHANE® #2 Pump Tube & PELLATHANE® Duckbill, ferrules 6 mm	UCTY2DCE	PK of 2	n/a	

Pump Tube Numbers

- #1 and #2 for 26-100 psi pump (when used with check valve).
- #1, 2, 3, 4, 5 for 0-25 psi pump.
- #7 tube for 26-100 psi single head pump only.

US and Canada 800.683.2378, International 904.641.1666

Check Valves

Injection Check Valve 1/4"



Injection Check Valve 3/8"



Injection Check Valve 6 mm



CHECK VALVES 26-100 psi (1.7-6.9 bar)

DESCRIPTION	PART NUMBER	UM	PART NUMBER	UM
Check Valve includes SANTOPRENE® duckbill, ferrules 1/4'	UCDBINJ	EA	MCDBINJ	PK of 5
Check Valve includes PELLATHANE® duckbill, ferrules 1/4'	UCTYINJ	EA	MCTYINJ	PK of 5

Check Valve includes SANTOPRENE® duckbill, ferrules 3/8'	UCINJ38	EA	MCINJ38	PK of 5
Check Valve includes PELLATHANE® duckbill, ferrules 3/8'	UCTYIJ38	EA	MCTYIJ38	PK of 5

EUROPE

Check Valve includes SANTOPRENE® duckbill, ferrules 6 mm	UCINJCE	EA	MCINJCE	PK of 5
Check Valve includes PELLATHANE® duckbill, ferrules 6 mm	UCTINJCE	EA	MCTINJCE	PK of 5

For Your Records

Model: _____

Serial Number: _____

Date of Installation: _____

US and Canada 800.683.2378, International 904.641.1666



STENNER

Peristaltic Metering Pumps
Since 1957

Stenner Pump Company

**3174 DeSalvo Road
Jacksonville, Florida 32246**

Phone: 904.641.1666

US Toll Free: 800.683.2378

Fax: 904.642.1012

sales@stenner.com

www.stenner.com

Hours of Operation (EST):

Monday 7:00 am–5:00 pm

Tues.–Fri. 7:00 am–5:30 pm

© Stenner Pump Company

All Rights Reserved

CM1207